

**BLAUPUNKT**

12V/24V  
DIGITAL VIDEO RECORDER  
**BP 9.1A** 2-CHANNEL



MADE IN  
KOREA



*Enjoy it.*

## CAUTIONS

---

- Please insert the micro SD card in the right direction to avoid damage to the card or the device. If device shows error message, please format the micro SD card from device menu. Please reset device or change micro SD card if similar error continues.  
Note : All files will be deleted when formatting micro SD card or firmware update, please backup the important files prior to that. When reset function is selected, the device will return to default setting.
  - Blaupunkt does not warrant the performance of device if used with other Micro SD card other than Blaupunkt Micro SD card
  - New Micro SD card must be formatted for first use.
  - Ensure bracket is installed correctly & firmly on windscreen to avoid damage to device and for better recording angle.
  - Please do not use product under wet environment as device is not waterproofed/ water resistant.
  - Please do not record or take picture facing sunlight.
  - To obtain clear image, please clean windscreen and device lens regularly. Avoid using device in dusty environment.
  - Handle device with care and avoid direct impact on the device. Avoid using device in high electromagnetic environment.
  - Please operate the product within the temperature of -20°C ~ 80°C. Continuous exposure to sunlight, especially when locked in cabin where temperature exceeds 80°C may result to device malfunction, colour change, housing and image distortion.
- Disclaimer :**
- Blaupunkt is not liable for any loss or damage caused or resulting from unauthorized disassembly or modification to the product.
  - In no event shall Blaupunkt be liable for any direct, indirect, punitive, incidental, special consequential damages, to property or life, improper storage, whatsoever arising out of or connected with the use or misuse of our products.
  - USA & CANADA : Products not intended for sales in the United States and Canada. If purchased in the U.S. or Canada, this product is purchased as-is. No warranty, expressed or implied is provided in the U.S. and Canada.
  - This device is NOT intended to be used for illegal purpose, surveillance and shall not be used in any form as evidence for claim purposes.
  - Some countries prohibit drivers from mounting anything on the windshield, or restrict mounting to specific areas of the windshield. It is the owner's responsibility to mount the device in compliance with local laws.
  - Error may occur depending on the surrounding environment and the voltage of the car.
  - Blaupunkt is not liable/responsible for non-recorded event, missing files, etc.
  - If the car battery voltage is lesser than the setting value of cut-off voltage, device will stop recording even at park recording mode.

# STRUCTURE

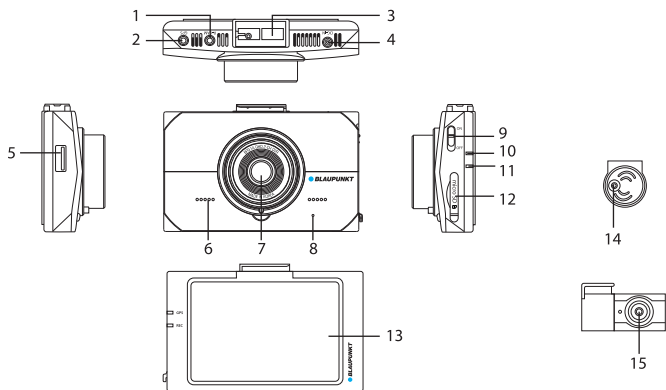

1. Rear camera connecting cable output
2. GPS tracking cable input
3. Bracket hole
4. Power cable input
5. Wireless control dongle input
6. Speaker
7. Lens
8. Microphone

9. On/Off
10. GPS tracking light
11. Recording indicator light
12. Micro SD card slot
13. LCD touch screen
14. Rear camera connecting cable input
15. Rear lens

## Features

- Resolution : Front 4MP 2K 2048 x 1152 (30fps), Rear 2MP FHD 1920x1080 (30fps)
- Wide viewing angle : Front - 118°, Rear - 120°
- Screen display : Front, Rear, PIP (picture in picture)
- 3.5" LCD touch screen display
- Format-free Technology
- Fixed High Temperature Cut-off
- Variable Low Car Battery Voltage Cut-off
- 24-hour Park Monitoring-ready with Smart Motion
- Automatic Display Shutdown
- Built-in G-sensor
- Loop Recording
- Supported Format : AVI
- ADAS-ready : LDWS & FVSA (Optional GPS Tracker required)
- Preview, Download, Playback Videos & Settings Configuration via Wireless Control App
- Built-in microphone & speaker
- Language : English, Korean, Japanese, Thai, Chinese
- Power supply : DC 12V ~ 24V
- Support up to 128GB Class 10 Micro SD
- Dimension (WxHxD) : Front 30x64x98mm, Rear 26x53x28mm
- Weight : Front 90g, Rear 24g (without cable)
- Includes : Front DVR & rear DVR, 16GB Micro SD Card, Micro SD card adapter, 3M Bracket, DVR Power Cable, Rear Camera Connecting Cable, Wireless Control Dongle & Manual

# FUNCTION

## System Setup

Tap the left side of the LCD screen to enter into MENU while recording. Tapping right side of the screen will enter into different Video mode instead of MENU

Mode	Category	Function
Quick Menu	Live	Live Image
	Menu	Setting Menu
	Mute	Voice REC ON/OFF
	VoiceGuide	Speaker ON/OFF
	PlayList	Playback List
	Parking Mode	Parking Mode ON/OFF
	OSD	OSD On/Off
	Front LED	LED On/Off
Time	Time Set	Set Time
	Standard Time Set	Set Standard Time
	Summer Time	Set Summer Time
System	Wi-Fi	Wi-Fi On/Off
	Cut Off Voltage	Set voltage for car constant power discharge
	Auto LCD Off	Off after 30sec/on 60sec
	Language	Set Language
	High Temp Cut Off	Set High Temperature Cut Off
	Speaker Volume	Set Speaker Volume
Camera	Camera Set	Adjust Brightness, Contrast, Chroma
REC Set	Night Vision	Set Brightness for Night Time Parking Mode
	Front Video Quality	Set Front Video Quality
	Rear Video Quality	Set Rear Video Quality
	REC Mode	Continuous / Shock
	REC CH	Set REC Channel
	Mic Volume	Set REC Volume
	Motion Level	Set Motion Sensor Level
	Shock Level (N)	Set Shock Sensor Level (Driving)
	Shock Level (P)	Set Shock Sensor Level (Parking)
Others	System Info	Display System Information
	Recording Settings	Adjust REC Folder Capacity Rate & Timelapse Speed Control
	Touch Calibration	Calibrate Touch Screen
	SD Card Format	Format Micro SD Card
	Factory Init	Initialize Configuration
ADAS	Operating Speed	Speed Set for LDWS
	Warning	Alert
	LDWS	ADAS Setting
	FVSA	Set Forward Vehicle Start Alert during Driving

# PAIRING GUIDE

## Android Smartphone Pairing (supports Android 8.0 & above)

- Download "Blaupunkt DVR BP9" app from Google Play.
- Ensure distance range between the DVR and the smartphone is approximately 10 meters in an open field environment.
- Install Wireless Dongle on the DVR USB port.
- Ensure DVR is connected to the power source and is turned ON.
- Ensure the smartphone Location setting is ON and Mobile Data setting is OFF.
- Ensure the smartphone WiFi setting is ON.
- Turn on DVR WiFi.

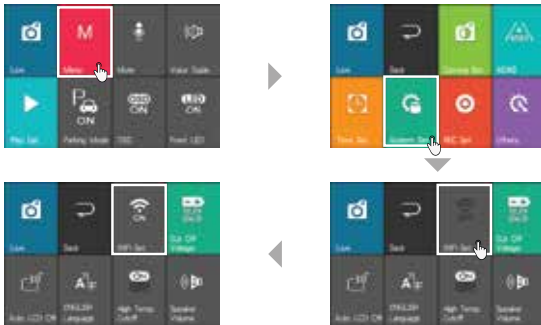

- Open "Blaupunkt DVR BP9" App, then tap on START to connect.
- Android smartphone (Ensure Location is turned on before connecting to DVR)  
Go to smartphone Wi-Fi setting to search and connect to DVR Wi-Fi - 'Blaupunkt\_...' and key in '00000000', if device request for password.
- These options will appear after selecting "START" :

**Live View, VOD View, Download View, Configuration** (Figure 2).



Figure 1



Figure 2

**IMPORTANT NOTICE:**  
For security purposes, after the Android smartphone is successfully connected to the device, it is advisable to change the WLAN security password. Please refer to page 8 for password and update details

## PAIRING GUIDE

### iOS Smartphone Pairing (supports iOS 10.0.2 & above)

- Download "Blaupunkt DVR BP9" app from App Store.
- Ensure distance range between the DVR and the smartphone is approximately 10 meters in an open field environment.
- Install Wireless Dongle on the DVR USB port.
- Ensure DVR is connected to the power source and is turned ON.
- Ensure the smartphone WiFi setting is ON.
- Turn on DVR WiFi.

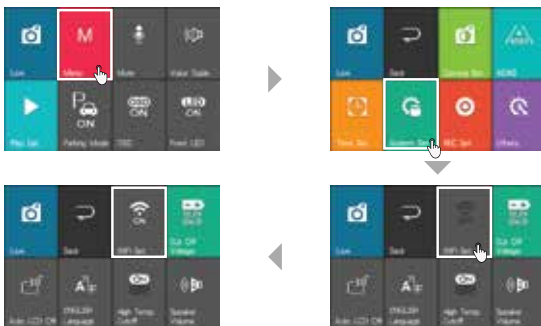

- Open "Blaupunkt DVR BP9" App, then tap on START to connect.
- iOS smartphone (Ensure Location is turned on before connecting to DVR)  
Go to smartphone Wi-Fi setting to search and connect to DVR Wi-Fi - 'Blaupunkt\_...' and key in '00000000', if device request for password.
- After successful pairing, enter into mobile app to start. At Main Menu select "START" at Home Page (Figure 1).
- These options will appear : **Live View, VOD View, Download View, Configuration** (Figure 2).



Figure 1



Figure 2

**IMPORTANT NOTICE:**  
For security purposes, after the iPhone smartphone is successfully connected to the device, it is advisable to change the WLAN security password. Please refer to page 8 for password and update details

## FUNCTION



### LIVE VIEW (Show real time video)

1. Select to change Front or Rear camera view
2. Select to start or stop recording
3. Select to return to MENU
4. Select to view recorded video



### VOD VIEW (Playback List)

1. Normal Video Playlist
2. Event/Emergency Playlist
3. Park Monitoring Playlist
4. Return to MENU
5. Play recording
6. Download recording



### DOWNLOAD VIEW

1. Normal Video Playlist
2. Event/Emergency Playlist
3. Park Monitoring Playlist
4. File Sharing (Support Android)
5. File Separation (Support Android/ iOS)
6. Return to MENU
7. Play recording
8. Delete downloaded file



## CONFIG SETTINGS

### Basic settings

1. Mode setting
2. Front video quality
3. Rear video quality
4. Motion level
5. Shock level (Parking)
6. Shock level (Driving)
7. Speaker
8. Speaker volume
9. Mic
10. Mic volume
11. Cut-off voltage
  - Setting on LCD Screen :  
Menu > System Set > Cut Off Voltage
  - Setting on Wireless Control App :  
Configuration > Cut-Off Voltage
12. High temp shutdown
13. Auto LCD off time
14. OSD (On Screen Display) setting
15. Speed unit
16. Front LED
17. Recording channel
18. Night vision
19. Language
20. WLAN enable
21. LDWS (Lane Departure Warning System) speed
22. LDWS warning
23. ADAS settings
24. FVSA (Front Vehicle Departure Alert)
25. Recording settings
26. Parking Mode





## System settings

1. Standard time set
2. DST (Daylight saving time)
3. Camera sensor setting
4. Adjust ratio of memory (**All data will be deleted when ratio setting is adjusted, backup data before changing the setting**)



## Reset

All setting will be reset to default setting



## Format SD card

All data will be deleted after formatting



## WLAN security

Change wireless connection password by entering alphabetical or numerical characters. Device will be reset to default setting when resetting the password. Default password : 00000000



## FIRMWARE INFORMATION

# FUNCTION

## Blaupunkt DVR BP9.1A PC Viewer

Visit [www.blaupunkt.com/ase](http://www.blaupunkt.com/ase) to download below viewer.



### NOTE :

Older files will be overwritten whenever the card memory is full and new storage space is required. Backup recordings regularly to prevent important files from being overwritten.

### Retrieved File

1. Select the "E" (Event File) icon from "FILE TYPE". 
2. "Double Click" on the preferred file to playback ,then "Double Click" again on the front or rear video.
3. Select the "📁" icon to extract preferred file, then preferred saving folders to download the recordings.
4. Refer to the preferred folders to playback the downloaded recordings.

## SPECIFICATIONS

---

Resolution : Front : 4MP, 118° wide viewing angle, Rear : 2MP, 120° wide viewing angle

Display mode : Front, Rear, PIP

Screen display : 3.5" Touch Screen (320x480)

Mode : Video

G-sensor : Supported

Memory : Support up to 128GB Class 10 Micro SD

Resolutions : Front : 2048 x 1152 FHD (30fps), Rear : 1920x1080 FHD (30fps)

Loop recording : 120MB/43sec

Video format : AVI

Exposure : -5 ~ +5

24hr Monitoring : Supported

Motion detection : 60MB/21sec

Built-in : G-sensor, microphone, speaker

Display shutdown : Supported

Language : English, Korean, Japanese, Thai, Chinese

Playback Function : Supported

Power Supply : DC 12V ~ 24V

Operating temperature : -20° ~ 70°

Storage temperature : -30° ~ 80°

Time zone : GMT -11.00 ~ +12.00

Format-free Technology : Supported

## ACCESSORIES

---

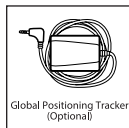
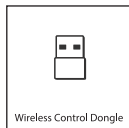
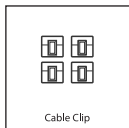
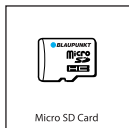
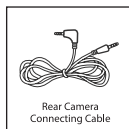
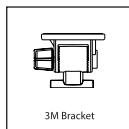
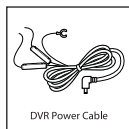
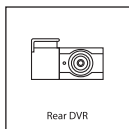
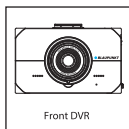

\*Subject to change

