

**BLAUPUNKT**



# POWER AMPLIFIER **EMA 265**



*Enjoy it.*

**Operating and Installation Instructions**

## INTRODUCTION

Proper system planning is vital in order to maximize the device's performance and road safety. Plan your installation carefully to avoid compromising performance reliability of the system. Consult an authorized Blaupunkt dealer for installation or repairation. Read the manual carefullt before operating the device for the first time.

### Safety Notes

Ensure to follow below safety notes during installation and wiring connection: -

- Disconnect the negative terminal of the battery. Refer to the safety notes of the vehicle manufacturer.
- Ensure positions of the holes are nowhere near the vehicle component to avoid any damage during drilling.
- Ensure cross section of the cable is no less than 2.5mm<sup>2</sup> if the positive and negative cables are too long.
- Incorrect installation may result in malfunction of the device or the car sound system.

### Installation and Connection Instructions

- Select a dry and well-ventilated location to install the device.
- The device must not be installed in overly exposed location such on therear shelf, rear seat etc.
- The installation location must be suitable for screw holes and have stable ground support.

### Integrated Fuse

The integrated fuse in the device protects the output voltage and the entire electrical system in case of malfunction. Do not replace damaged fuse with higher current.

### Disclaimer

In no event shall Blaupunkt be liable for any direct, indirect, punitive, incidental, special consequential damages to property or life and whatsoever arising out of or connected with the use or misuse of our products.

USA & CANADA: This product is not intended for sale in the United States and Canada. If purchased in the U.S. or Canada, this product is purchased on as-is basis. No warranty, whether expressed or implied is provided in the U.S. or Canada.

### General Safety Notes

Observe the following to protect yourself against injuries :

- The supply voltage requirement is 12V DC with grounded negative connection. Unauthorised dismantling or modifying may void the warranty of the device. Blaupunkt is not liable for any loss or damaged caused or resulting from unauthorized repairation or modification to the device. Refer to a Blaupunkt specialist in case of any installation or repairation required.
- The device's core components may be damaged when the car is driven on bumpy roads for a prolonged period of time or if it is used to play non-standard volume level.
- Please do not operate the car radio under extreme temperature conditions (extremely high temperature or extremely low temperature); ensure the temperature within the car ranges from -10°C to 85°C (Storage temperature : 5°C to 35°C) before connecting to the power supply.
- For abnormalities, please refer to TROUBLESHOOTING. Consult a specialist if theproblem persist.
- Solvents, cleaning and scouring agents as well as dashboard spray and plastics care products may contain materials which can damage the surface and screen of the device. Use only dry or slightly moistened cloth to clean the device.

### Recycling and Disposal



Do not dispose of your old unit in the household trash! Use the return and collection systems available to dispose of the old device.

This manual may be updated from time to time without any notice.

## INPUT FUNCTION

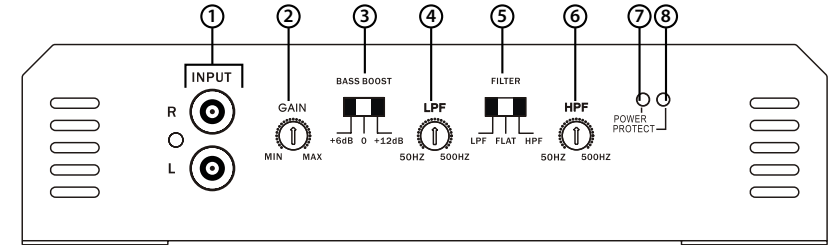

1. 2 Channel RCA Input Jack
2. Gain Control
3. Bass Boost Control
4. LPF Control
5. HPF/LPF/FLAT Control
6. HPF Control
7. POWER Indicator
8. PROTECT Indicator

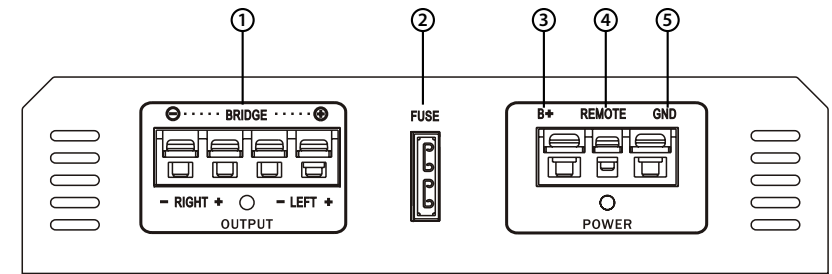

1. 2 Channel Speaker Output Connection
2. Fuse (25Ax1)
3. +12V Connection
4. REM Control
5. GND Control

## SPECIFICATION

### Power

- Voltage Supply : 11-15V
- Idling current : 0.43A
- Fuse : 25A x 1
- Consumption @ 2Ω, 14.4 VDC : 12A (Max Musical Power)

### Amplifier

- Amplifier Class : CLASS AB
- Channel : 2/1
- PCB Layer : 1
- Max Output Power @ 4 ohms : 120W x 2
- RMS Power 4 ohms : 60W x 2
- RMS Power 2 ohms : 100W x 2
- RMS Power 4 ohms Bridge : 160W x 1
- Pre-in Sensitivity : 300mV-6V
- Signal-To-Noise Ratio : 90dB
- Frequency Response : 20Hz-22kHz
- Gain Adjust : 300mV-6V
- Bass Boost Frequency : 55Hz
- Bass Boost Level : 0/6/12dB
- Total Harmonic Distortion : ≤0.05%
- RCA Input : 2 Channel
- Crossover Frequency : 50Hz-500Hz (L), 50Hz-500Hz (H)
- Dimension (W x H x D) : 200 x 200 x 51.5mm
- Net Weight : 1.05kg

## WIRING DIAGRAM

### Stereo Mode

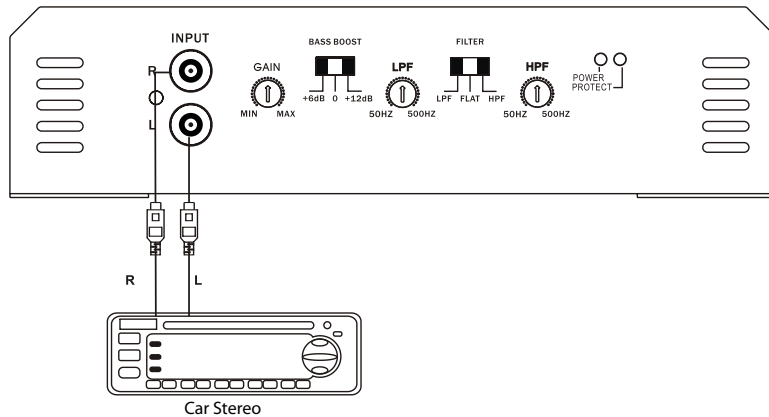

## WIRING DIAGRAM

### Speaker Connections

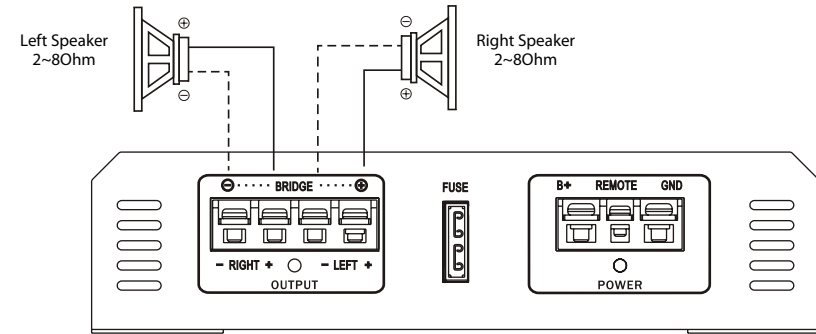

### Bridged Mode

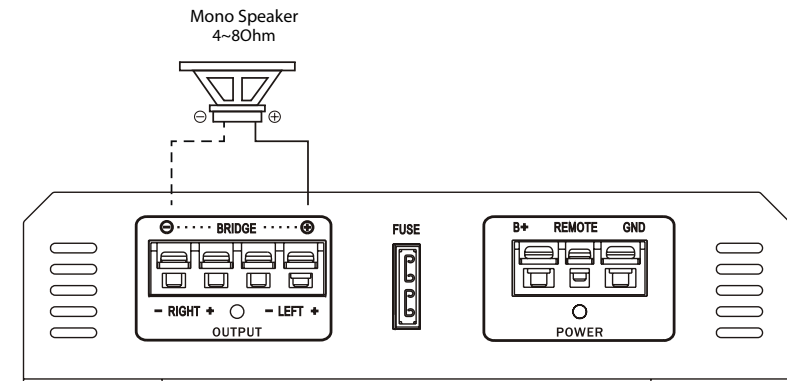

### Power Connection Leads

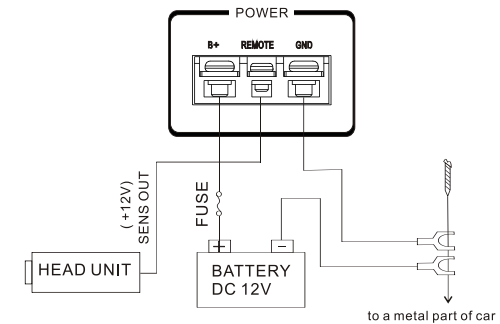

## WIRING DIAGRAM

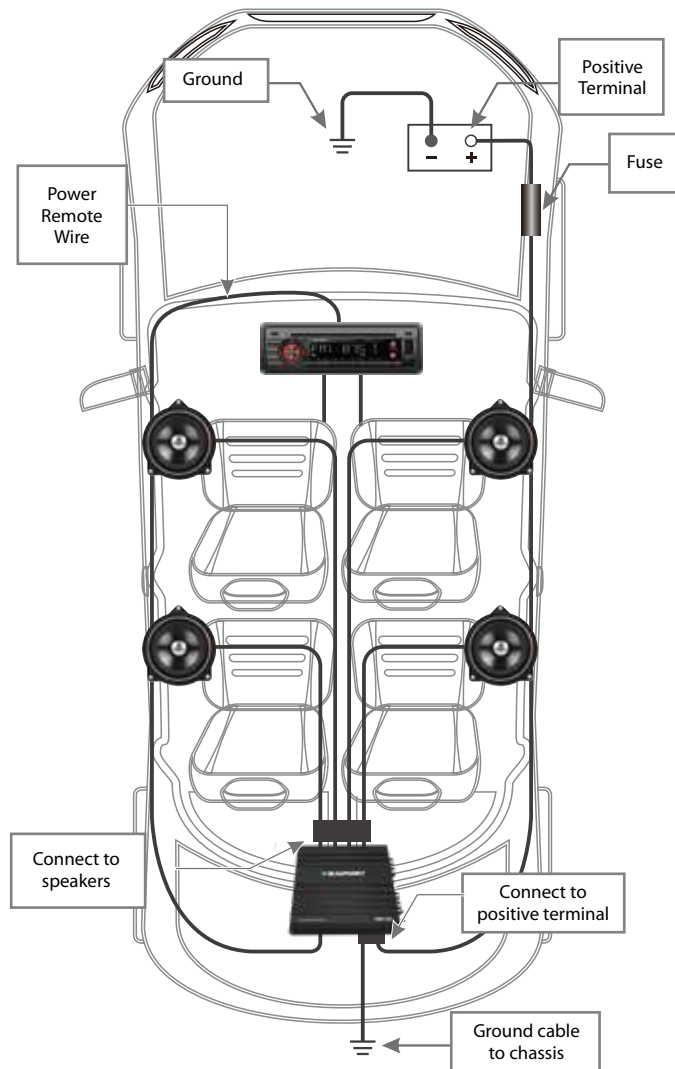

**⚠ WARNING**  
Do not connect negative charge of the battery to the positive charge before installation.

## TROUBLESHOOTING

If any of the following problem occur, please resort to Troubleshooting for the possible solutions. Consult Blaupunkt authorized dealer if problem persist.

Problems	Possible Causes	Solutions
No audio output	Remote wire failed to work	Examine voltage output/connection and repair accordingly.
	Fuse failed to work	Examine power integrity and reversed polarity, repair or replace fuse accordingly.
	Disconnected power wires	Examine power wire and ground connections. Replace and repair accordingly.
	Missing output from source or audio input not connected	Examine input connection and signal integrity. Replace or repair accordingly.
	Disconnected speaker wires	Examine speaker wires. Replace or repair accordingly.
Unstable audio cycle	Broken speaker	Examine radio system. Replace or repair accordingly.
	Thermal protection will be activated when amplifier temperature exceeds 90°C	Improve amplifier's ventilation accordingly.
	Poor audio input	Examine input connection. Replace or repair accordingly.
Audio distortion	High amplifier sensitivity setting, exceed maximum output capability of amplifier	Refer to manual to reset gain setting.
	Low impedance	Examine speaker impedance. Rewire speaker accordingly, if below 2Ω stereo or 4Ω mono.
	Improper connection of speaker and amplifier	Examine speaker wire, replace or repair accordingly. Refer to manual for installation instruction.
	Broken speaker	Examine radio system. Replace or repair accordingly.
Poor bass response	Wrong speaker wire polarity connection causing phase cancellation	Examine speaker polarity and repair accordingly.
Broken battery fuse	Low impedance	Examine speaker impedance. Rewire speaker accordingly, if below 2Ω stereo or 4Ω mono.
	Incorrect power connection	Examine power wire and ground connections. Repair accordingly.
	Fuse used is smaller than recommended	Replace with recommended fuse type.
	Over drawn current	Examine speaker impedance. Rewire speaker and replace fuse accordingly, if below 2Ω stereo or 4Ω mono.
	Incorrect power wire	Examine power wire and ground connections. Repair accordingly.
Broken amplifier fuse	Over drawn current	Examine speaker impedance. Rewire speaker and replace fuse accordingly, if below 2Ω stereo or 4Ω mono.
	Fuse used is smaller than recommended	Examine power wire and ground connections and repair accordingly with correct fuse.

