

 **BLAUPUNKT**

 **BLAUPUNKT**
Brand
established
1924
GERMANY

CAR RADIO
HOKKAIDO 100



Enjoy it.

Operating and Installation Instructions

CAUTIONS

Safety Notes

This car radio has been manufactured according to established safety guidelines. However, dangers may still occur if the safety notes in this manual is not observed. This manual is intended to familiarize the user with the car radio's important functions. Read this carefully, prior to using the car radio. Keep this manual in an easily accessible location. In addition, do observe the instructions of the devices used in conjunction with this car radio.

Road Safety

Always observe the following notes for road safety:

- Car radio must be used in a way that compliments safety of the user when driving the vehicle. It is recommended for the user to park at an appropriate location when operating the car radio. While driving, user is not recommended to use applications that can be prone to distraction e.g. streaming to medias etc.
- Radios with Navigation : User is recommended to proceed with proposed driving routes only if it does not violate any traffic regulations. Local traffic signs and regulations always prevail over the routes proposed.
- User is advised to keep the volume of the car radio to a moderate level for the protection of the ears and to increase the ability to hear any emergency warning signals (e.g. police and ambulance sirens). Do not increase the car radio volume while the car radio is muted as it is not audible. The car radio volume can be too loud when the car radio is unmuted.

General Safety Notes:

Observe the following for protection against injuries:

- This car radio is intended for installation and operation in a vehicle with 12V vehicle system outage, hence the radio unit must be installed in a DIN slot. Observe the output limits of the car radio. Do not dismantle or modify the car radio. Installation and repairs, if necessary, should be performed by a specialist. We are not liable for any loss or damage caused or resulting from unauthorized disassembly or modification to the product.

- This car radio's core components may result to damage when the car is driven on bumpy roads for a prolonged period of time or if it is used to play non-standard or severely damaged discs.
- Please do not operate the car radio under extreme temperature conditions (extremely high temperature or extremely low temperature); make sure that temperature within the car ranges from -20°C to 80°C before you connect the car radio to the power supply.
- For abnormalities, please refer to the "Troubleshooting" section. If the problem cannot be resolved, please press the Reset button to recover its factory settings. Otherwise, please contact respective installer/seller directly for help.
- As SD/USB file formats, codecs, bitrate, resolution and other parameters available in the market are not all the same, there is no guarantee that this car radio can play all media file formats.
- Different cars may have different configurations. It is normal that some CAN-Bus functions cannot be enabled because it is not supported by the user's car or this car radio.
- Solvents, cleaning and scouring agents as well as dashboard spray and plastics care products may contain materials which can damage the surface and screen of the car radio. Use only dry or slightly moistened cloth to clean the car radio surface and screen.

This manual may be updated from time to time without any notice.

Disclaimer

In no event shall Blaupunkt be liable for any direct, indirect, punitive, incidental, special consequential damages to property or life and whatsoever arising out of or connected with the use or misuse of our products.

USA & CANADA: This product is not intended for sale in the United States and Canada. If purchased in the U.S. or Canada, this product is purchased on as-is basis. No warranty, whether expressed or implied is provided in the U.S. or Canada.

CAUTIONS

Disposal Notes



Do not dispose of your old unit in the household trash!
Use the return and collection systems available to dispose of the old device.

Radios with Detachable Panel - Damage to the control panel

- Never drop the control panel.
- Transport the control panel so that it is protected against impacts and the contacts cannot become dirty.
- Do not expose the control panel to direct sunlight or another heat source.
- Avoid direct skin contact

Scope of Delivery

- Car sound system
- Operating / installation instructions
- Remote control (include battery)
- Connecting cable
- Installation keys
- Trim ring
- Mounting bar

KEY FUNCTIONS



1 Radio mode

- Press to switch between radio band FM1 - FM2 - FM3 or press and hold for automatic radio stations scan and save.

Playback mode

- Press to select songs (use **20** or **19** to select position of the digit, turn the knob (**6**) to select the number, then press **6** to confirm to play track.

Phone (BT) mode

- Press to end call.

2 Press once to turn on or off.

3 Media mode

- Press to switch between media RADIO - USB - SD - BT - AUXIN.

Phone (BT) mode

- Press to answer call.

4 MUTE

5 Press to switch EQ between ROCK - POP - CLASS - JAZZ.

6 Turn knob left/right to increase/decrease volume or press knob to switch between

BAS : Bass
TRRE : Treble
BAL : Balance
FAD : Fader
LOD : Loud
EQ : Equalizer

and turn left/right to adjust.

7 LCD Display

8 IR Sensor

9 Press to view time or press and hold to adjust time setting.

10 USB

11 AUX-IN

12 SD

Radio mode

- Use digit to select radio station or press and hold to save the station.

Playback mode

- Press to skip to next 10th song or press and hold to skip to the next folder.

13 Radio mode

- Use digit to select radio station or press and hold to save the station.

Playback mode

- Press to skip to previous 10th song or press and hold to skip to previous folder.

14 Radio mode

- Use digit to select radio station or press and hold to save the station.

Playback mode

- Press to turn on/off shuffle play.

15 Radio mode

- Use digit to select radio station or press and hold to save the station.

Playback mode

- Press to repeat ONE/ALL.

16 Radio mode

- Use digit to select radio station or press and hold to save the station.

Playback mode

- Press to play the first 5sec of each track.

17 Radio mode

- Use digit to select radio station or press and hold to save the station.

Playback mode

- Press to PAUSE/PLAY.

18 Radio mode

- Use digit to select radio station or press and hold to save the station.

Playback mode

- Press to PAUSE/PLAY.

19 Radio mode

- Press and hold until MANUAL appear to manually increase the frequency. Or repeat press and hold until AUTO appear to increase the frequency automatically.

Playback mode

- Press to skip to next track.

20 Radio mode

- Press and hold until MANUAL appear to manually decrease the frequency. Or repeat press and hold until AUTO appear to decrease the frequency automatically.

Playback mode

- Press to begin the track again or press twice to skip to previous track.

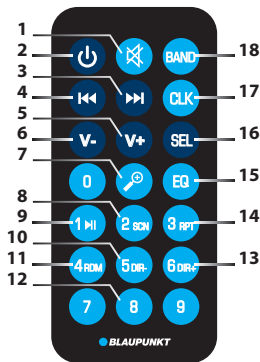

1 Mute

2 Power

- Press to turn on or press and hold to turn off.

Media mode

- Press to switch between media RADIO - USB - SD - BT - AUXIN.

3 Radio mode

- Press and hold until MANUAL appear to manually increase the frequency. Or repeat press and hold until AUTO appear to increase the frequency automatically.

Playback mode

- Press to skip to next track.

4 Radio mode

- Press and hold until MANUAL appear to manually decrease the frequency. Or repeat press and hold until AUTO appear to decrease the frequency automatically.

Playback mode

- Press to begin the track again or press twice to skip to previous track.

5 Increase volume

6 Decrease volume

7 Radio mode

- Press to broadcast each saved radio station for 5sec or press and hold for automatic radio stations scan and save.

- 7 Playback mode**
- Press to select songs (use 3 or 4 to select position of the digit, adjust the number with 5 or 6 to select the number, then press 19 to confirm to play track.
- 8 Radio mode**
- Use digit to select radio station or press and hold to save the station.
- Playback mode
- Press to play the first 5sec of each track.
- 9 Radio mode**
- Use digit to select radio station or press and hold to save the station.
- Playback mode
- Press to PAUSE/PLAY.
- 10 Radio mode**
- Use digit to select radio station or press and hold to save the station.
- Playback mode
- Press to skip to previous 10th song or press and hold to skip to previous folder.
- 11 Radio mode**
- Use digit to select radio station or press and hold to save the station.
- Playback mode
- Press to turn on/off shuffle play.
- 12 Digit button**
- 13 Radio mode**
- Use digit to select radio station or press and hold to save the station.
- Playback mode
- Press to skip to next 10th song or press and hold to skip to the next folder.
- 14 Radio mode**
- Use digit to select radio station or press and hold to save the station.
- Playback mode
- Press to repeat ONE/ALL.
- 15 Media mode**
- Press to switch between media EQ OFF - FLAT - POP - ROCK - CLASS - JAZZ.
- 16 Press this button to sund setting.**
- 17 Press to view time or press and hold to adjust time**

setting.

18 Radio mode

- Press to switch between radio band FM1 - FM2 - FM3.

BLUETOOTH

Pre-pair Bluetooth

- Ensure mobile phone supports Bluetooth function before pairing. Different mobile phone will have different emissive power. To get the best connection, the recommended distance range is 3m without any object obstruction.

Pairing

- Turn on mobile phone's Bluetooth to set up. (Please refer to the instruction manual of the mobile phone on how to operate Bluetooth)
- "Hokkaido 100 BT" should appear on your available Bluetooth scanning list.
- Select "Hokkaido 100 BT". Pairing successful when phone's Paired Device list appear as "Connected" under Hokkaido 100 BT.

General

Power supply (12V).....	11 ~ 16V
Current Consumption	max. 10A
Max. power output.....	4 x 50W
Dimension (WxDxH).....	180 x 120 x 55mm
Weight.....	0.318kg
Operation temperature.....	-20° ~ 60°

FM Stereo Radio

Frequency range.....	87.5 - 108MHz
Preset memory stations.....	18
Sensitivity	<20dB
Stereo separation	>25dB
SNR.....	>60dB

Audio Specification

Frequency response	20Hz - 20kHz
Speaker impedance	4 ohms

Playback

USB/SD.....	MP3, WMA
Display.....	ID3 display
Distortion	<0.3%
SNR.....	>60dB

Bluetooth

Profile	A2DP
---------------	------

Aux-In	3.5mm jack
---------------------	------------

TROUBLESHOOTING

If any of the following problem occur, please resort to Troubleshooting for the possible solutions. Consult Blaupunkt authorized dealer if problem persist.

Problems	Possible Causes	Solutions
Unable to start up	The car key is not inserted into the ignition; ignition is off	Insert the car key and turn on the ignition.
	Power Cable is not inserted into the main body.	Insert the power cable.
	Burnt power fuse .	Replace it with a new fuse.
	Drained car battery.	Charge or replace the car battery.
No sound	Audio cables are not properly connected to the unit.	Ensure proper connection of the audio cables.
	Mute setting is on.	Unmute the volume.
	Low volume.	Adjust the volume.
	No sound from front, rear, left & right speakers due to Fade-Balance settings.	Select Equalizer from Home Page to adjust setting.
Slow in SD card reading	SD card may contain corrupted files or virus.	Replace it with a new audio/video SD card with compatible file formats.
Unable to search radio stations	Radio's antenna is not well inserted.	Ensure radio antenna is properly installed.

WIRING DIAGRAM

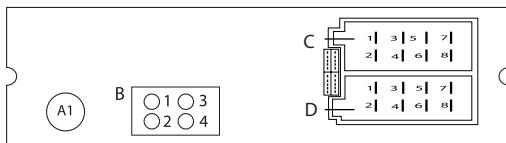

NO.	WIRE	A
1	RADIO ANTENNA	

NO.	WIRE	B
1	RCA	FL
2	RCA	FR
3	RCA	RL
4	RCA	RR

NO.	C
1	REAR RIGHT +
2	REAR RIGHT -
3	FRONT RIGHT +
4	FRONT RIGHT -
5	FRONT LEFT +
6	FRONT LEFT -
7	REAR LEFT +
8	REAR LEFT -

NO.	WIRE	D
1	-	-
2	-	-
3	-	-
4	YELLOW	B+
5	BLUE	ANT
6	-	-
7	RED	ACC
8	BLACK	GND

INSTALLATION INSTRUCTION

SAFETY

- Assign a mounting location that will not obstruct driver in any circumstances. Or cause injuries to drivers and passengers in case emergency brake or accidents.
- Ensure all wires are connected properly, and that the unit is functioning well before fitting the unit into the mount.
- Any unauthorized installation and modification may cause malfunction to the unit. Always use the parts that are included with the units only.

CAUTION

- Disconnect the negative terminal of the battery (Refer to vehicle manufacturer's safety instructions). Be wary to not damage vehicle components when drilling holes.
- Make sure you do not damage vehicle components when drilling any holes.
- The cross sections of the positive and negative cables must not be less than 1.5 mm².
- Do not connect the vehicle's plug connectors to the radio!
- Your vehicle may differ from the description provided here. Blaupunkt is not liable in case any damage caused by incorrect installation or connection.
- Please contact Blaupunkt dealers or vehicle's manufacturer if information provided here does not fit your specific installation requirement.

When installing amplifier, first connect the device ground connections before connecting the plugs for the line-out jacks.

Ground connection of external devices may not be connected to ground of car sound system (housing).

Supplied mounting hardware

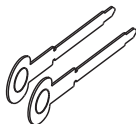
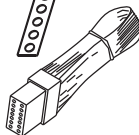
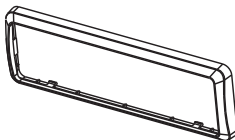
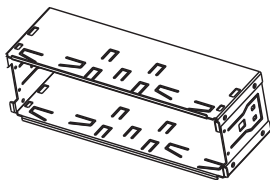

Optional accessories

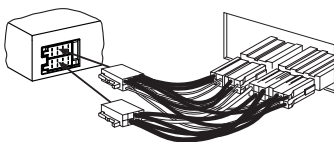

INSTALLATION INSTRUCTION

Installation kit

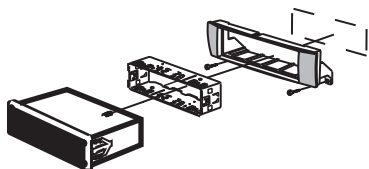

1.

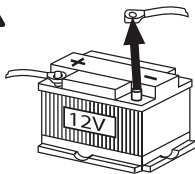

2.

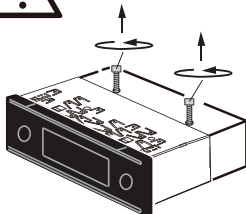

3.

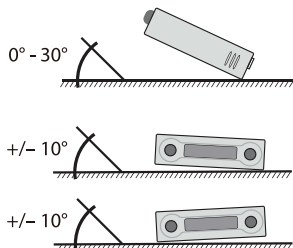

4.

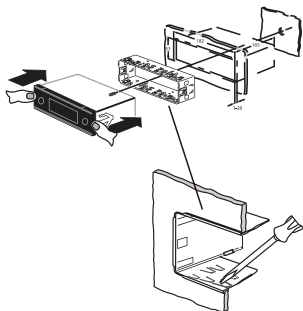

DISMANTLE INSTRUCTION

1.

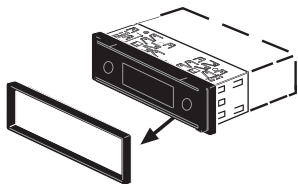

2.

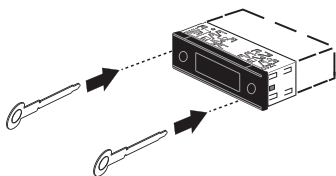

3.

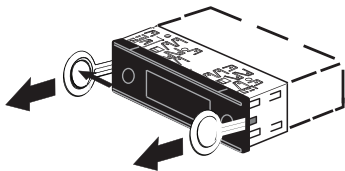

4.

