

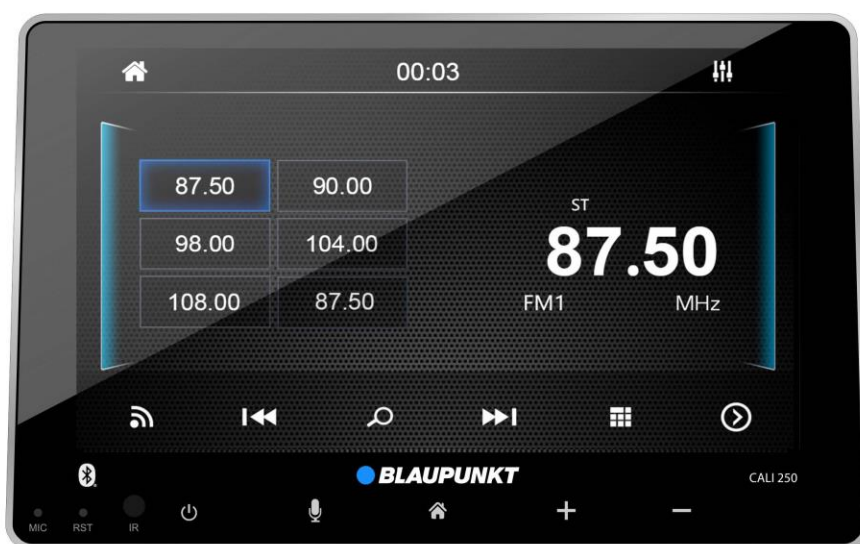

MULTIMEDIA PLAYER CALI 250



Enjoy it.

Operating instructions

CONTENT

SAFETY INFORMATION	3
INSTALLATION.....	4-5
ELECTRICAL CONNECTION	6
THE PLAYER.....	7
REMOTE CONTROL	8
MAIN MENU	9
RADIO OPERATION.....	10-12
MUSIC/VIDEO OPERATION.....	12-16
BLUETOOTH OPERATION	16-19
AV IN OPERATION	19-20
EQUALIZER OPERATION.....	20-21
SETTINGS OPERATION	21-23
PERFORMANCE.....	24

SAFETY INFORMATION

Use This Product Safely

This set has been designed and manufactured to assure personal safety. Improper use can result in electric shock or fire hazard. The safeguards incorporated in this unit protect you if you observe the following procedures for installation, use and servicing. This unit doesn't contain any parts that can be repaired by the user.

When Driving

Keep the volume level low enough to be aware of road and traffic conditions.

When Car Washing

Do not expose the product to water or excessive moisture. This could cause electrical shorts, fire or other damage.

When Parked

Parking in direct sunlight can produce very high temperatures inside your vehicle. Give the interior a chance to cool down before starting playback.

Use the Proper Power Supply

This product is designed to operate with a 12 volt DC

Use Authorized Service Centers

Do not attempt to disassemble or adjust this precision product. Please refer to the Service Center list included with this product for service assistance.

For Installation

The unit should be installed in a horizontal position with the front end up at a convenient angle, but not more than 30°.

Notes:

- Choose the mounting location where the unit will not interfere with the normal driving function of the driver.
- Before finally installing the unit, connect the wiring temporarily and make sure it is all connected up properly and the unit and the system work properly.
- Use only the parts included with the unit to ensure proper installation. The use of unauthorized parts can cause malfunctions.
- Consult with your nearest dealer if installation requires the drilling of holes or other modifications of the vehicle.
- Install the unit where it does not get in the driver's way and cannot injure the passenger if there is an emergency stop.
- If installation angle exceeds 30° from horizontal, the unit might not give its optimum performance.

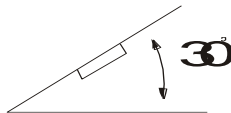

INSTALLATION

- Avoid installing the unit where it would be subject to high temperature, such as from direct sunlight, or from hot air, from the heater, or where it would be subject to dust, dirt or excessive vibration.

Installation Method

1. Take out the outer trim frame, insert the keys supplied on both sides to remove the mounting sleeve.
2. Bend the TABS outward, if necessary. (two places above and below are appropriate) Then insert the mounting sleeve into the dashboard.
3. Insert the unit into the mounting sleeve, and then insert outer trim frame to the unit.
4. Install the nozzle part into the unit on the dashboard.

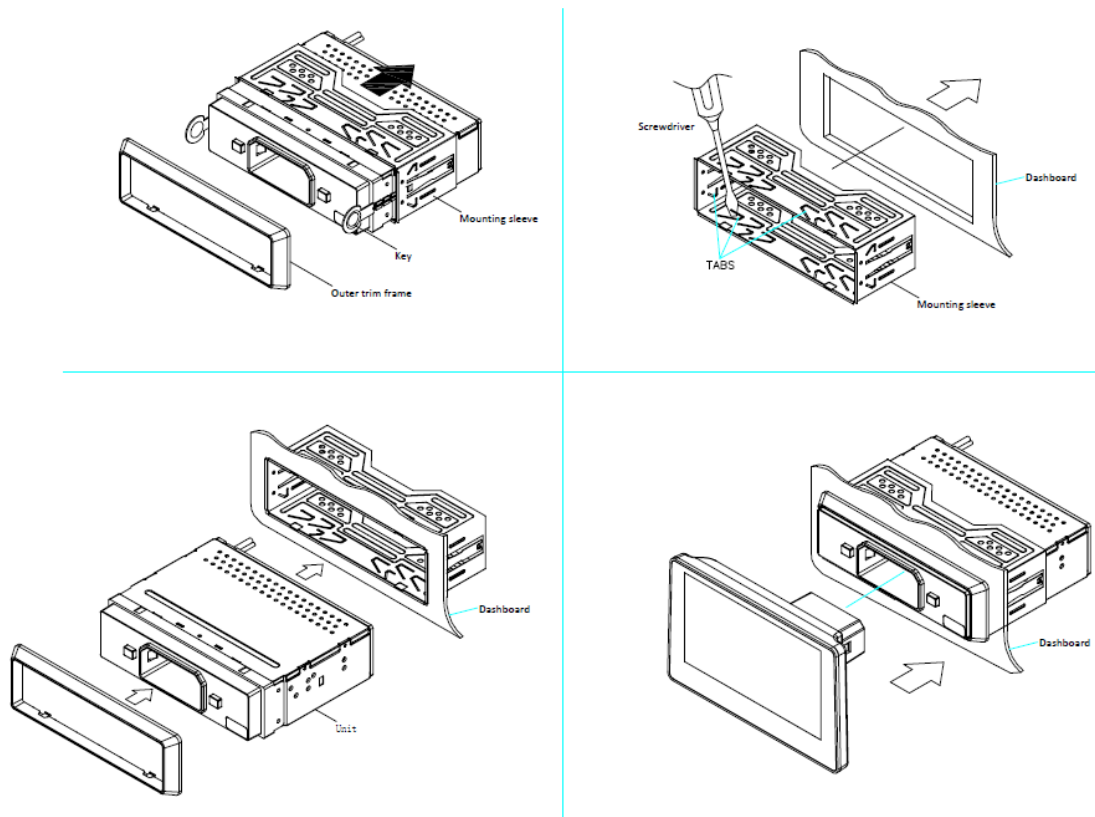

INSTALLATION

ATTENTIONS OF INSTALLATION

1. This player should be installed by professional technician.
2. please read the instruction and operation of equipment carefully before installing.
3. Make sure to connect other wires before power connection.
4. To avoid short circuit. Please make sure all the exposed wire are insulating.
5. Please fix all the wires after installation.
6. Please make connection to the player accordingly to this instruction manual.

Wrong connection may cause damage.

7. This player only fit for 12V DC device and please make sure your car belongs to this kind of cathode grounding electrical system.

8. Please connect the wires rightly. Wrong connection will cause malfunction or damage the electrical system.

ELECTRICAL CONNECTON

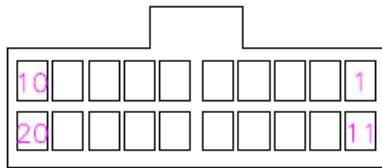
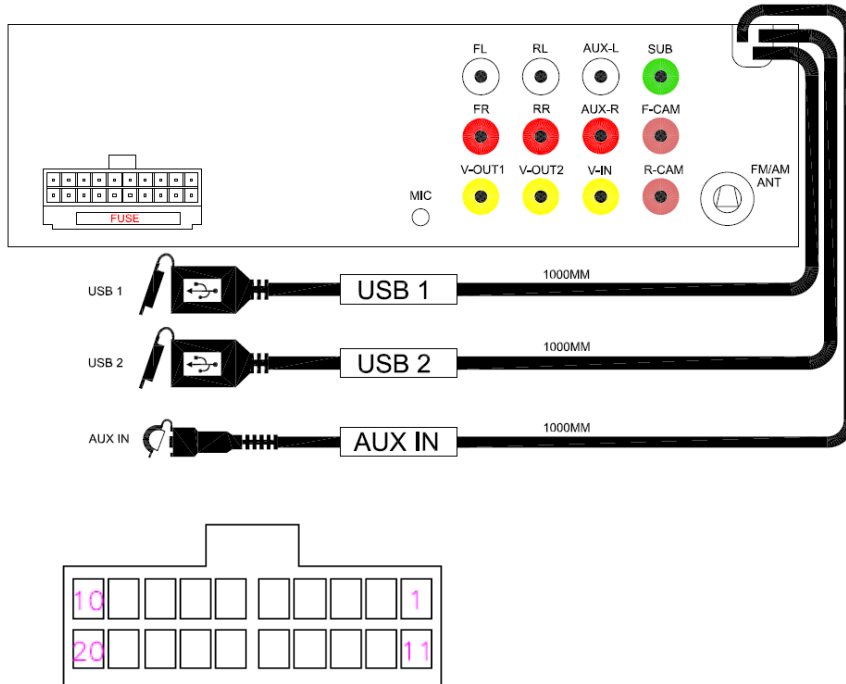

WIRE INSERTION VIEW

PIN NO.	WIRE COLOR	WIRE TYPE	DESCRIPTION
1	GRAY	20# WIRE	SWC 1
2	PINK	20# WIRE	Rear CAM trigger
3	ORANGE	20# WIRE	ILL
4	BROWN	20# WIRE	PARKING
5	BLUE	20# WIRE	POWER ANTENNA
6	BLUE/WHITE	20# WIRE	AMP remote out
7	GRAY/BLACK	20# WIRE	RIGHT FRONT SPEAKER (-)
8	GRAY	20# WIRE	RIGHT FRONT SPEAKER (+)
9	PURPLE/BLACK	20# WIRE	RIGHT REAR SPEAKER (-)
10	PURPLE	20# WIRE	RIGHT REAR SPEAKER (+)
11	GREEN	20# WIRE	SWC 2
12	ORANGE/BLACK	20# WIRE	Front CAM trigger
13	BLACK	20# WIRE	SWC GND
14	RED	20# WIRE	ACC
15	YELLOW	16# UL WIRE	BATTERY+
16	BLACK	16# UL WIRE	GROUND
17	WHITE/BLACK	20# WIRE	LEFT FRONT SPEAKER (-)
18	WHITE	20# WIRE	LEFT FRONT SPEAKER (+)
19	GREEN/BLACK	20# WIRE	LEFT REAR SPEAKER (-)
20	GREEN	20# WIRE	LEFT REAR SPEAKER (+)

Attention:

1. Please make sure "B+" and "ACC" pin location are correct before making connection. These two pins may be different in different cars. Wrong connections of these two pins will burn the fuse.
2. "Parking" wire must be connected to "ground" in order to activate the video function.
3. This player can only be used by the 12V DC cathode grounding electrical system.
4. Don't connect the terminals of the car battery until the player is absolutely with well erection joint.
5. Please make sure to connect the yellow wire to the positive of the battery (+).
6. When change the fuse. Please make sure the specifications are same.
7. Using good quality speaker with 4-8 ohm can result in the best effect of the equipment.

THE PLAYER

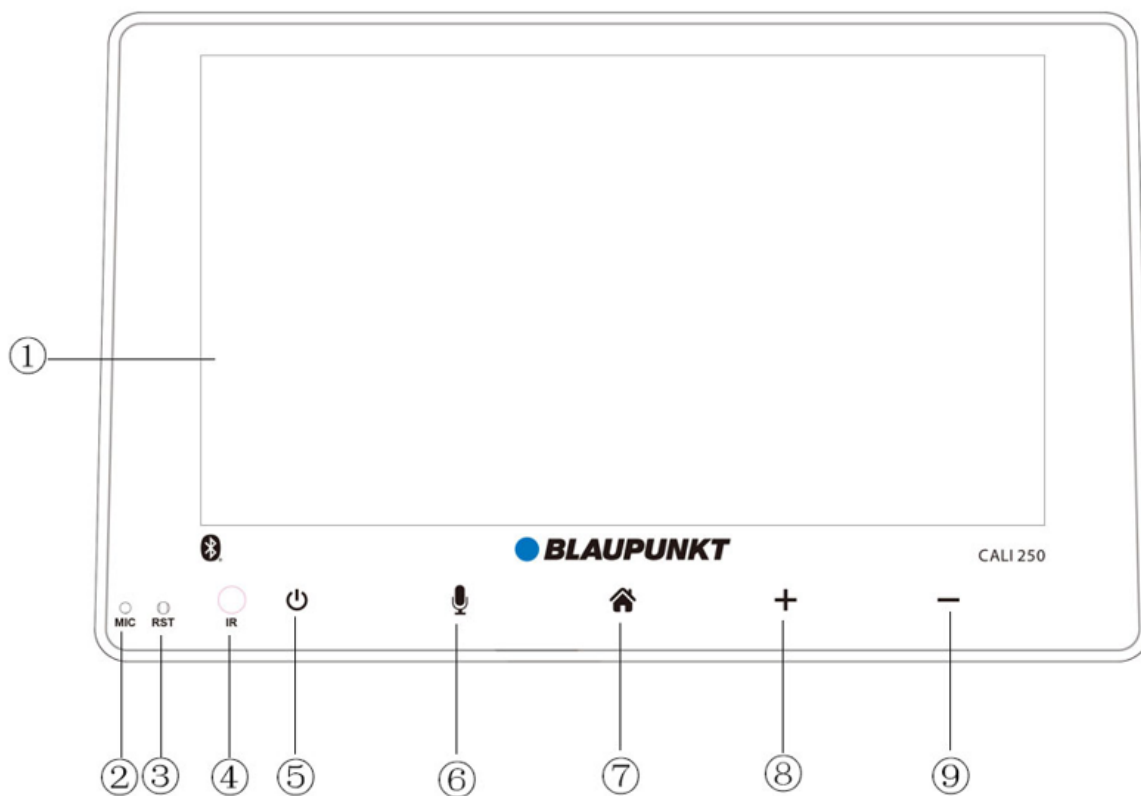

1. Touch screen user interface
2. Microphone
3. RESET button. Restore to default factory settings of the device. Caution! All personal settings will be lost!.
4. IR remote Sensor.
5. POWER/MUTE button.
6. Vocal button.
7. Main menu button.
- 8/9. Volume up/down button.

Remote control

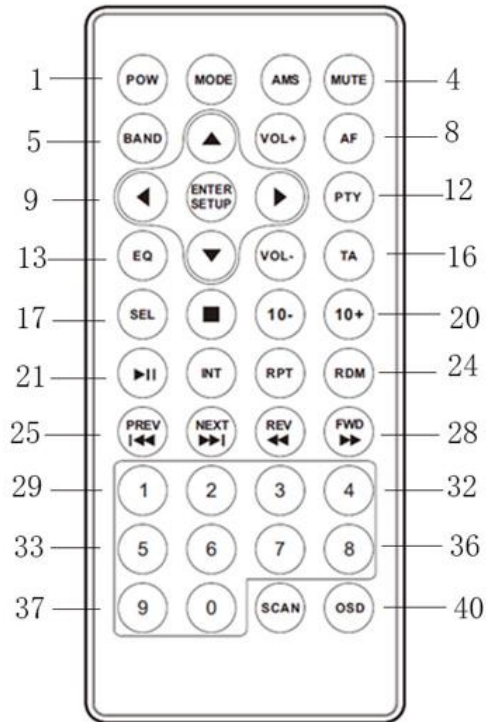

- 1 POW: Switching device on/off.
- 2 MODE: Select source.
- 3 AMS: Preset scan/Auto store.
- 4 MUTE: Mute on/off.
- 5 BAND: Select radio band
- 6/9/11/14:
 - 7/15: VOL+/-: Volume up/down.
- 8 AF: AF on/off.
- 10 ENTER/SETUP: Confirm/setup
- 12 PTY: PTY selection.
- 13 EQ: Select EQ.
- 16 TA : TA on/off.
- 17 SEL: Select EQ/LOUD/BEEP.
- 18 ■: Stop the player.
- 19/20: +/- 10 songs skip.
- 21 ►|| : Play/Pause.
- 22 INT: Introduction.
- 23 RPT: Repeat.
- 24 RDM: Random.
- 25 PREV/|◀◀: Seek down/previous track.
- 26 NEXT/▶▶|: Seek up/Next track.
- 27 REV/◀◀: Fast reverse.
- 28 FWD/▶▶: Fast forward.
- 29-38 0-9: numbers 0-9.
- 39 SCAN: scan up.
- 40 OSD: Display off.

1. Aim the remote control at the remote sensor on the unit.
2. Replace the battery from the remote control or insert a battery insulator if the battery has not been used for a month or longer.
3. DO NOT store the remote control in direct sunlight or in a high temperature environment, as it may not function properly.
4. The battery can last up to for 6 months in normal conditions. If the remote control does not work, please change the battery.
5. Use "button shaped" lithium battery "CR2025" (3V) only.
6. DO NOT recharge, disassemble, heat or expose the battery to fire.
7. Insert the battery in the proper direction according to the



Replacing the lithium battery

When the range of operation of the card remote control becomes short or no function, replace the lithium battery with a new one. Make sure the battery polarity replacement is correct.

1. Pull out the battery holder while pressing the stopper.
2. Insert the button-type lithium battery with the (+) mark facing upward. Insert the battery holder into the remote control.

OPERATION

Switching on/off

- ☛ Switching on/off with the  button.
- ☛ For switch-off, hold the  button pressed for more than 2 seconds.

Switch on/off via vehicle ignition

If the car sound system is connected with the vehicle ignition and it was switched on with the  button, it is switched on or off with the ignition.

Volume

Adjusting the volume

You can adjust the volume in steps from 0 (off) to 40 (maximum).

- ☛ Turn the +/- button to change the volume.

Muting the car audio system (Mute)

Briefly press the  button to mute the device or to reactivate the previous volume.

Main menu (Home)

In the main menu, you press the buttons on the touch screen to call up the different sources and operating modes.

- ☛ In the current source, press the [] button. The main menu is displayed.

Display on/off

In the main menu, press [**Display Off**] to turn off screen display, the audio output will keep working. Touch anywhere on the screen and the display comes on.

Wallpaper

In the main menu, Press [**Wallpaper**] button to change the background picture.

Digital Clock

In the main menu, There is an digital clock to show YY/MM/DD/WEEK/TIME. Press any a source icon to exit this screen.



OPERATION

Note:

The figures used in these instructions are intended to facilitate explanation. Some details may vary in your device.

Radio mode

In the main menu, press the [Radio] button. The radio page menu is displayed.





Select FM / AM band

Up to 30 stations can be stored under the FM band and AM band.



- Press the [] button to change FM1/FM2/FM3/AM1/AM2 band.

Tuning into a station

Tuning into stations manually

- Briefly press the [] or [] button once or several times to change the frequency in increments.

Station seek tuning

- Press the [] or [] button for approx. 2 seconds to start station seek tuning. The radio tunes to the next receivable station.

Storing stations manually

- Press [] to select FM1/FM2/FM3/AM1/AM2 band.
- Received the desired station.
- Press one of the memory buttons [1]-[6] for approx. 2 seconds to store the current station at the button. The station is stored.

Storing stations manually

- Press [] to select FM1/FM2/FM3/AM1/AM2 band.
- Received the desired station.
- Press one of the memory buttons [1]-[6] for approx. 2 seconds to store the current station at the button. The station is stored.

Storing stations automatically (Travel store)

OPERATION

➤ Press [] to store the stations to [1] to [6] of FM1~FM3(or AM1/AM2) automatically.

Scanning stations

➤ Press the [PS] button to listen the preset stations [1] to [6] FM1~FM3(or AM1/AM2) for few seconds.

Directly enter frequency

➤ Press [] button then input desired station frequency and press [OK] button.

Adjusting the seek tuning sensitivity

The seek tuning sensitivity decides whether the automatic station seek tuning finds only strong stations or also weaker stations that may be noisy.

➤ Press [LOC] button to adjust the sensitivity of station seek tuning.

If **LOC** is displayed, only stations with a strong signal are found during seek tuning.

If **LOC** is not displayed, stations with a strong and weak signal are found during seek tuning.

Stereo/Mono switching

Change FM stereo to monochrome. It can reduce the noise when the signal is weak.

➤ Press [] button to switch Stereo/Mono.

➤ In Stereo mode, The ST is displayed in white.

➤ In Mono mode, The ST is not displayed.

RDS function

Many FM stations broadcast an RDS (Radio Data System) signal in addition to their programme in the Europe reception area that allows additional functions, such as the display of the station name.



Switching AF(Alternate frequencies) function on/off

If the AF function is activated, the car audio system automatically tunes into the best receivable frequency for the station that is currently set.

➤ In FM band, press [] button into the RDS menu.

➤ Press [AF] button to switch the AF function on/off.

OPERATION

- ☛ If the AF function is switched on, AF is displayed in white.

Switching the TA (Travel Announcement) function on/off

If the TA function is activated, the car audio system automatically receive travel announcement.

- ☛ Press [TA] button to switch the TA function on/off.
- ☛ If the TA function is switched on, TA is displayed in white.



Update the clock by RDS station

CT SYNC function is set to on. when received RDS station, the station clock time will be synchronized to the device within few minutes.

- ☛ In FM band, press [] button into the RDS menu.
- ☛ Press [CT SYNC] button to switch the CT SYNC function on/off.

Selecting the program type and starting seek tuning

You can select a program type with the PTY function to search for stations of a particular genre, for example, stations that broadcast rock music, sport events or news.

- ☛ In FM band, press [] button into the RDS menu.
- ☛ At PTY item, press [] button to display the program types.
- ☛ Scroll through the list with [▲] / [▼] and tap on the desired program type to start PTY seek tuning.

USB media playback

Basic information

The car audio system can be used to play MP3 files as well as MP3 or WMA files on USB data carriers.

In addition, you can view movies and images from USB data carriers on the display or a connected monitor.

For safety reasons, the playback of movies and images on the integrated monitor is allowed only while the vehicle is parked and the hand brake is applied. The "BRAKE" cable must be connected with the hand brake connection of the vehicle (see Connection diagram at the end of these instructions). The movie playback on an external monitor in the rear is possible while driving.

Notes:

Blaupunkt cannot guarantee flawless function of copy-protected USB data carriers available in the market.

Note the following information when preparing an MP3/ WMA data carrier: (max. 32GB)

- Naming of tracks and directories:
 - Max. 32 characters without the file extension ".mp3" or ".wma" (the use of more characters reduces the number of tracks and folders that the car audio system can recognize)
- USB format/file system: mass storage device / FAT / FAT16 / FAT32 (max. 32GB)
- File extension of audio files
 - .MP3 for MP3 files
 -

OPERATION

WMA for WMA files

Connecting a USB data carrier



- Insert the USB data carrier in the USB socket.
- The device automatically switches to USB mode. The data is read, and playback starts with the first media file recognized by the device.

Removing the USB data carrier

- Turn off the car audio system.
- Disconnect the USB data carrier

Audio playback from USB

The principles of audio playback (MP3/WMA) from data carriers are identical for all sources.

- Select the desired source via the main menu. The device changes to the desired source and the playback starts.
- If the playback does not start with the audio playback
- Press the [] button to display folder list.
- Press the [] button to display all audio folders in the data carrier.

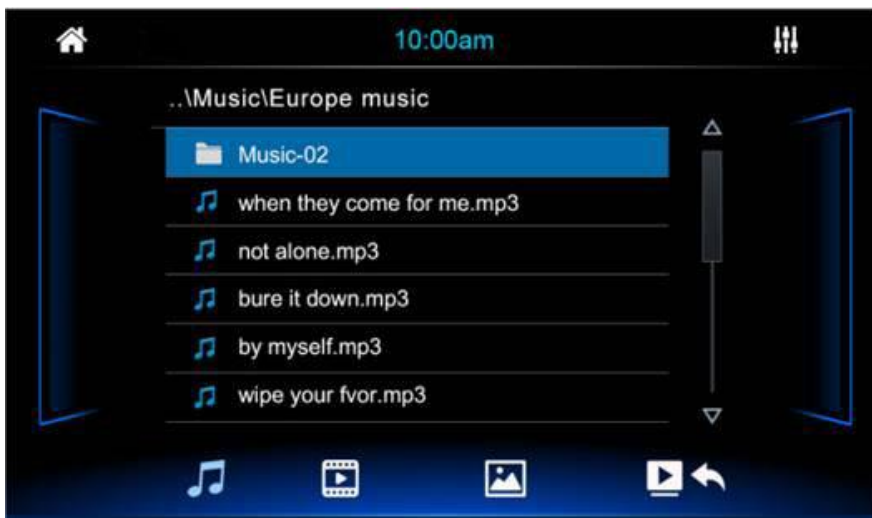

[△] Scroll up through the list page by page.









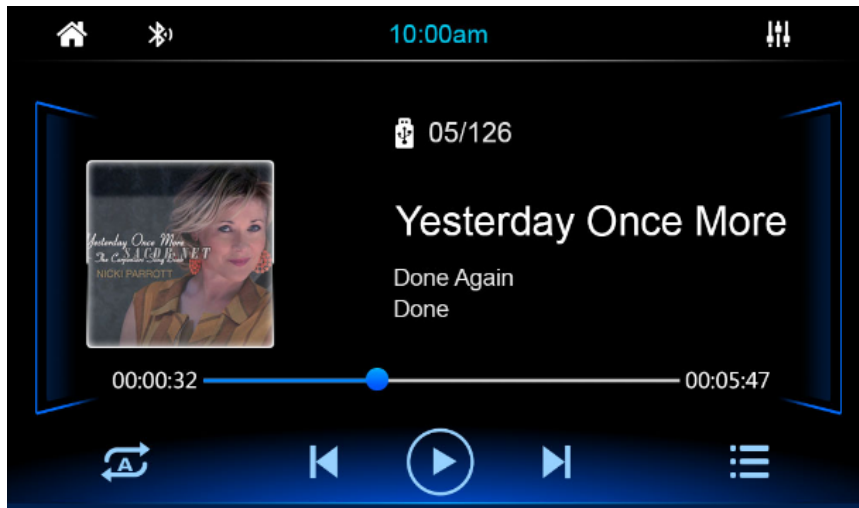

[▽] Scroll down through the list page by page

[] Return to playback page.



OPERATION

After choosing a title, the playback menu is displayed.



- [] Display the folder/file list.
- [] Next file.
- [] Previous file.
- [] Interrupt playback and continue playback.
- [] Repeat All files.
- [] Repeat the same files.
- [] Repeat all files of current folder.
- [] Back to the play list after finish the last file.
- [] Playback in random.
- [] Display equalizer.

Video playback from USB

- ☛ Insert the data carrier to the USB1 or USB2 socket, the playback starts.
- ☛ If the data carrier already in the device, select the USB1/USB2 source from the main menu.
- ☛ If the playback does not start with the video playback, Press [] button change to the playlist then press [] button to display all the folders of the data carrier, then select the desired file to play.

Note:

If you select a movie, playback starts. During movie playback, the playback menu is hidden.

- ☛ Briefly touch the touch screen once to display the playback menu again. The playback menu is shown.

OPERATION

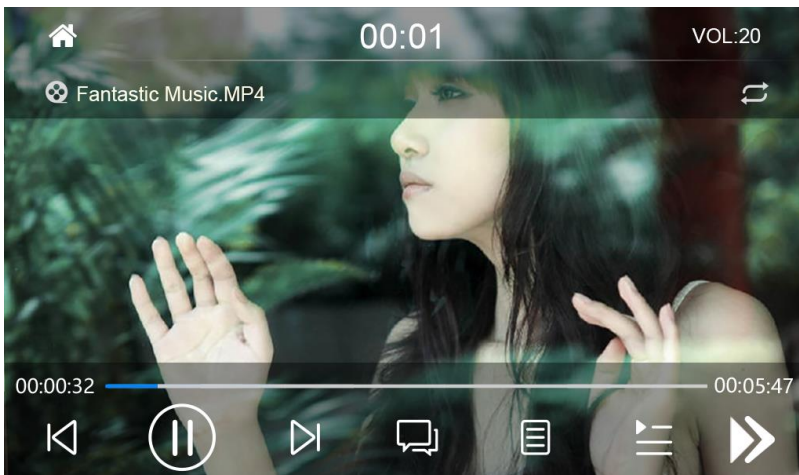

[] Display the folder/file list.

[] Next video.

[] Previous video.

[ / ] Interrupt playback and continue playback.

[] Change repeat mode: Repeat One/Repeat Directory/Repeat All/Repeat Off.

[] Repeat A to B.



[] Adjust the brightness.

Image playback from USB

☛ Insert the data carrier to the USB1 or USB2 socket, the playback starts.

☛ If the data carrier already in the device, select the USB1/USB2 source from the main menu.

☛ If the playback does not start with the video playback, Press [] button change to the playlist then press [] button to display all the folders of the data carrier, then select the desired file to play.

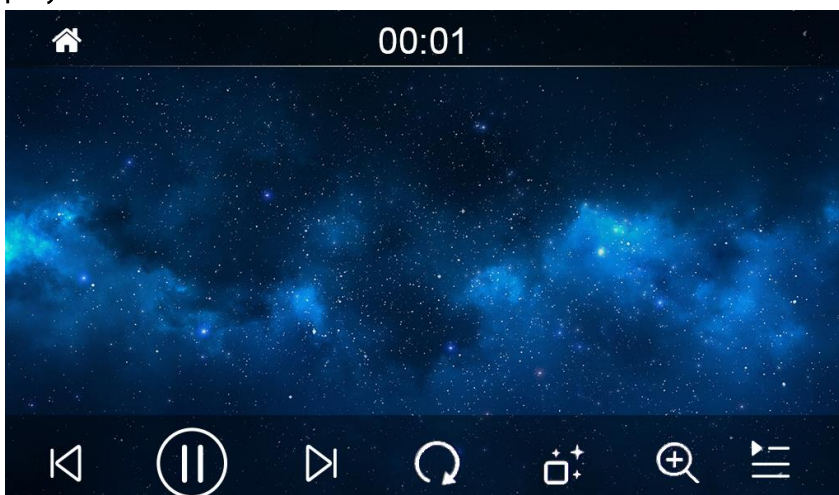

OPERATION

[▶|] Next image.

[|◀] Previous image.

[||▶] Interrupt playback and continue playback.

[🔄] Rotate image.

[📺+] Phantom play.

[🔍] Zoom in/Zoom out.

[☰] Display the folder/file list.

Bluetooth mode

The Bluetooth® function allows pairing cell phones & BT equipped media playback devices with the car audio system.

Once you pair a cell phone with the car audio system, you can make phone calls with the built-in hands free function. You can access the list of dialed numbers and the phone book of the registered cell phone after selecting “Sync” option.

If the connected Bluetooth® device supports the functions like A2DP and AVRCP, you can play music via the car audio system and control playback. During a call, music playback is interrupted and resumes again after the call.

If a cell phone is paired via Bluetooth® and a call is received during playback, the source playback is interrupted and the call menu is displayed.

Bluetooth pairing

☛ Select the Bluetooth item and search the Bluetooth device on your phone. Select “CALI 250” and input password “0000” if it needs a password. The BT icon will be displayed when successful paired.

Connection status



☛ If a mobile phone/device is connected with the car audio system, the Bluetooth® icon is displayed at the top left corner of the display in all audio/video sources.

Bluetooth PHONE mode

☛ Select In the main menu, press [Phone], the following menu appears.



OPERATION

- Press the [] button to disconnect the Bluetooth connection.
- Press the [] button to reconnect the Bluetooth connection.
- When the device is in range, the connection is established & the menu for the device is displayed.
- Enter a phone number with the keypad & press the [] button.
- Or -
- Briefly tap a contact / number via the caller list or phone book in the pop-up window. If there's an incoming call, the call menu is displayed.

[] Dialing page.

[] Dialing log page.



[] Phone book page.

[] Answer/dial out a call.

[] Reject/cancel a call.

[] talking back to the phone.

Phone book

- Press []. The following menu appears.
- Briefly touch [], the keypad will pop up. Input the letter to search contact .

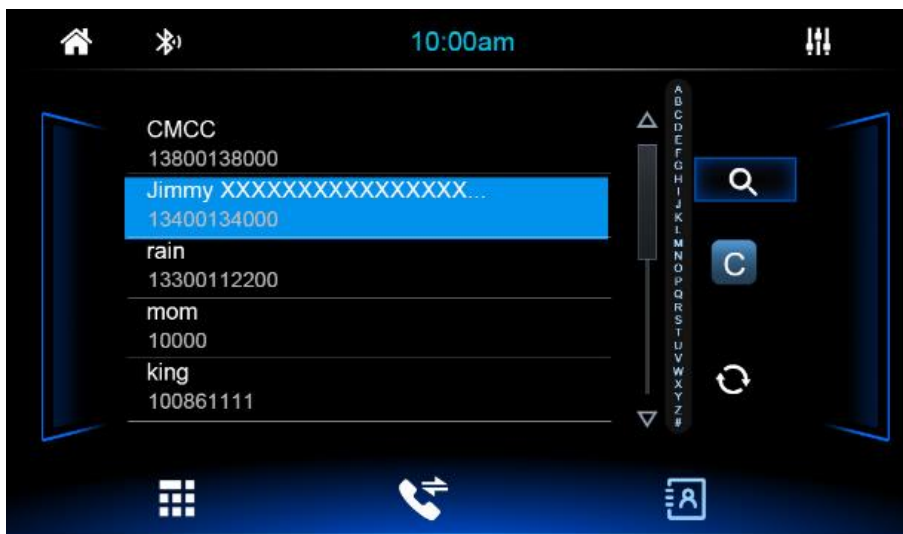

OPERATION

Note:

Phone book sync: To be able to access the phone Log / phone book of a connected mobile phone / device, you must allow sync phone book on your mobile phone. Car audio system support up to 1024 numbers.

Phone Log / Phone book download: Once device is paired with the car radio & sync option is selected the car radio begins downloading the phone log and phone book. Should this be interrupted the download will begin the next time the device is within range & connected to the car radio.

Phone Log

Press []. The following menu appears.

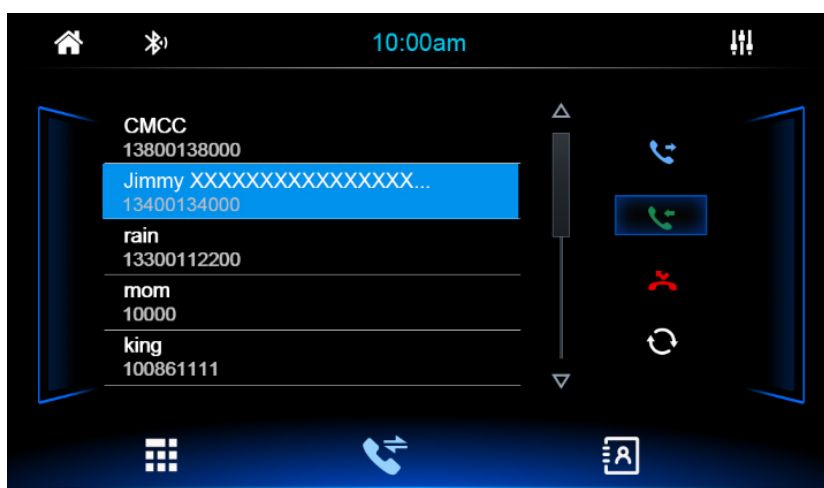

[] Dialed out number list.

[] Incoming call list.

[] Missed call list.

[] Sync call records.

[△] Scroll up through the list page by page.

[▽] Scroll down through the list page by page.

Vocal function

☛ Using the iPhone's cable to connect the USB1 of the unit and iPhone mobile. Press  button switch to the vocal mode.

☛ Press and hold the microphone icon in the middle of the display to activate the vocal function.

OPERATION



Bluetooth playback mode

Select In the main menu, press [BT Music], the following menu appears.

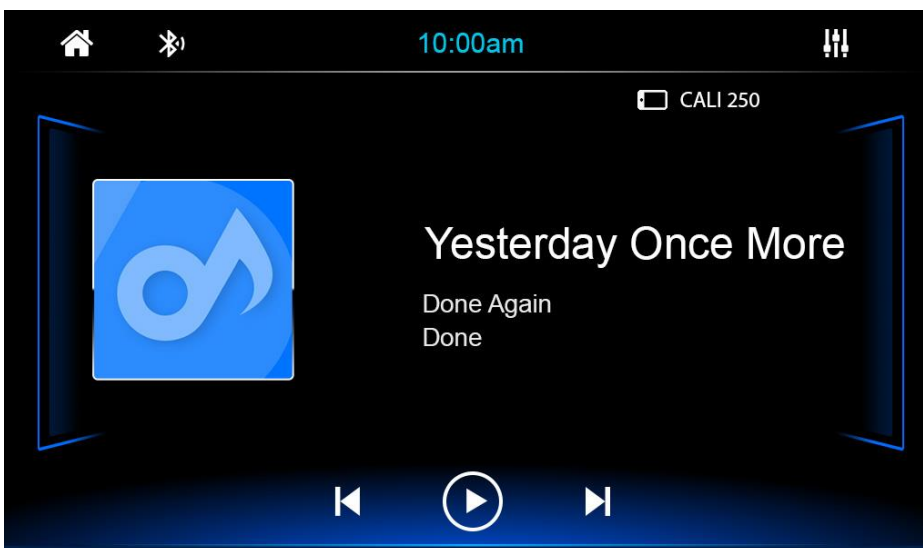

[▶] Next track.

[◀] Previous track.

[|| / ▶] Interrupt playback and continue playback.

External audio / video sources

AV-IN input

video playback. The AV-IN input is located at the rear of the radio.

☛ Select [AV IN] on HOME screen. The display shows the audio or video playback of this AV source.

OPERATION

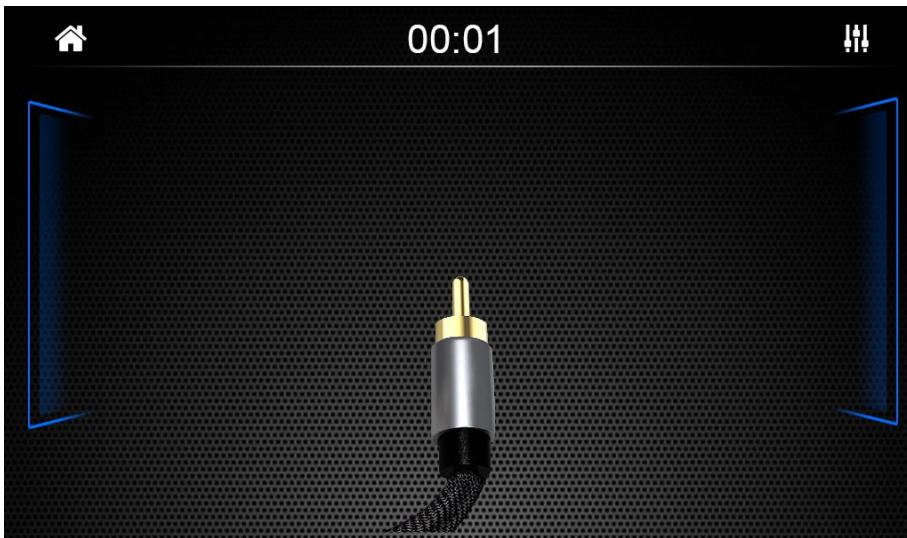

Rear Camera Input

This device features a video input at the rear of the device for connecting a rear view camera that is available as an option (sold separately). If a rear view camera is connected, the image is displayed on the screen, when the reverse gear is engaged.

- ☛ Connect REVERSE wire to reverse lamp power supply to detect when the reverse gear is engaged.

External monitor

This device features a video out for connecting an external monitor for passengers in the rear seat (see Connection diagram at the end of these instructions).

- ☛ Select the desired source via the main menu and start movie playback, e.g. from a USB. The image is displayed on the rear monitor.

Sound settings

Equalizer

You can adjust the equalizer for all sources.

- ☛ In the main menu or on the control bar of the current audio source, press the [EQ] or [] button. The equalizer menu is displayed.

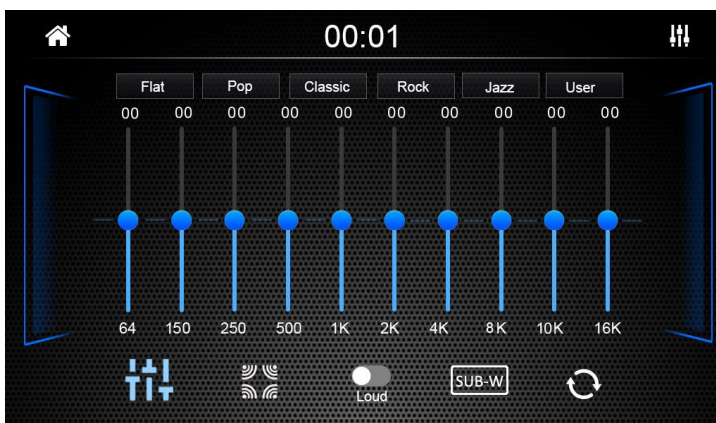

OPERATION

☛ Select a preset equalizer via the buttons.

-Or-

☛ Press the [**User**] button to set the levels of the available frequency bands according to your preferences.

Note:

With the [] button, you can reset the customized setting again.

Audio distribution (fader/balance)

You can adjust the sound distribution in the vehicle for all sources.

- ☛ In the main menu or on the control bar of the current audio source, press the [EQ] or [] button. The equalizer menu is displayed.
- ☛ Press the [**User**] button. The menu for fader and balance is displayed.

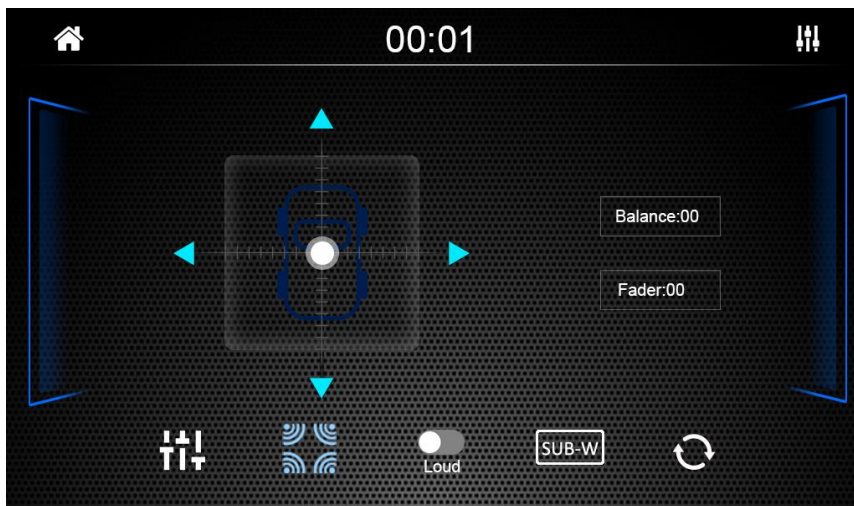

☛ Adjust fader & balance with [].

☛ Reset fader and balance to 0 with []

☛ Turn on the [**Loud**] button to increase bass at low volume.

☛ Press the [**SUB-W**] button to show the subwoofer interface, you can to on/off the subwoofer, adjusting subwoofer volume and select the LPF of subwoofer.

General settings

In the settings menu, you can adjust the general settings for the different functions of the device to suit your requirements.

- ☛ In the main menu, press the [Settings] button. The settings menu is displayed.

OPERATION

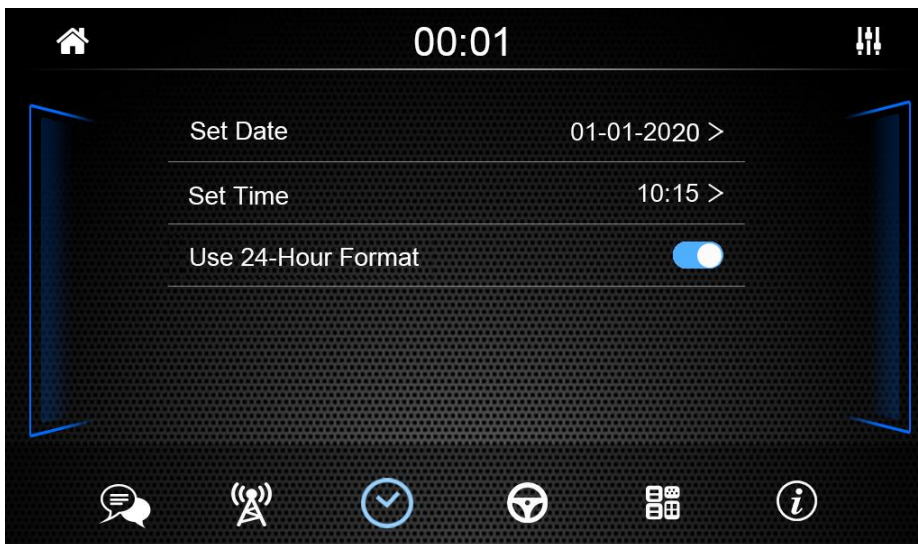

In this menu, following settings are possible:

- Set date.
- Set time.
- Use 24 hour format or 12 hour format.

Steel Wheel Control

Press [] button the SWC menu is displayed.

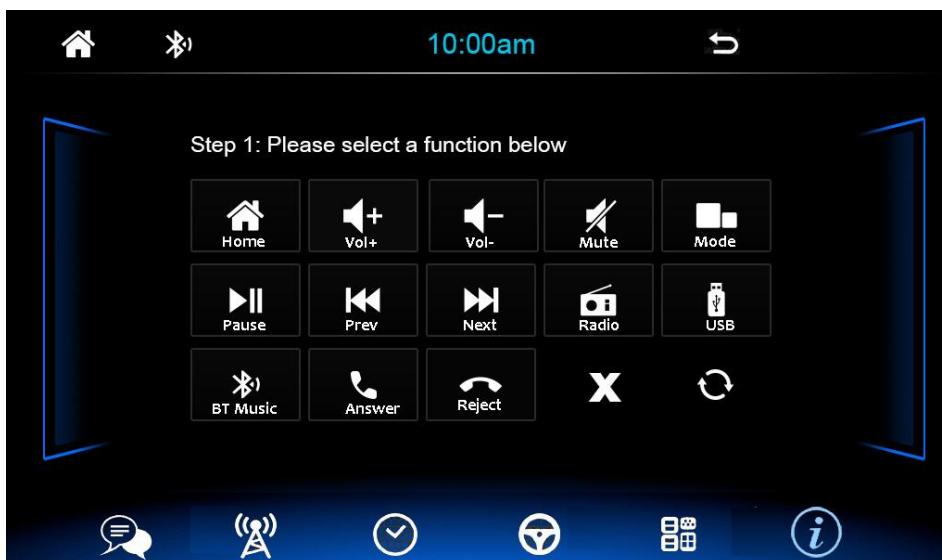

The buttons of the connected steering wheel control can be configured here.

Others

Press [] button the others menu is displayed.

OPERATION

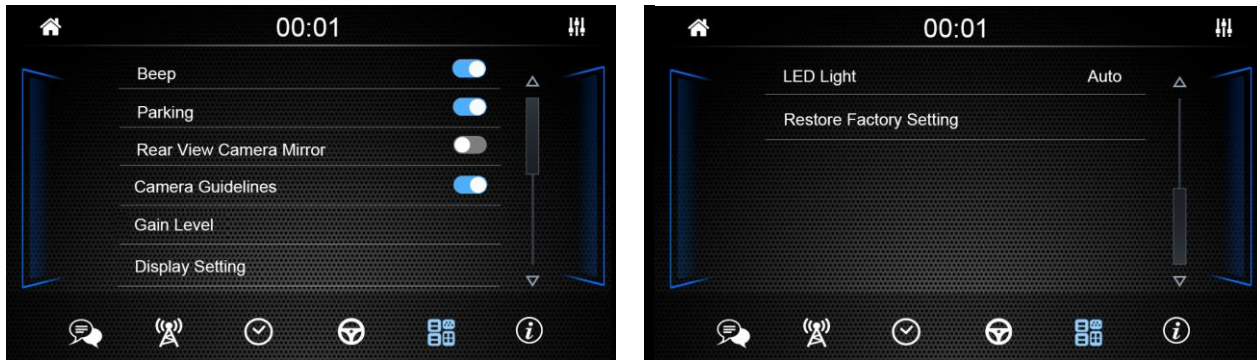

In this menu, following settings are possible:

- **Beep:** Switch beep sound on/off.
- **Parking:** Turn parking detect on/off.
- **Rear view camera mirror:** Invert rear camera image.
- **Gain level:** Setting USB/BT/AUX IN/AV IN source output level.
- **Display settings:** Adjust Brightness/Contrast/Saturation/Hue.
- **Restore factory settings:** Reset to factory settings. (**Note:** All the memories will be lost!)

-**Software version:** Press [] button the current software version is displayed.



PERFORMANCE.

Appendix 1

Radio and Audio parameters:

	FM	AM	MP3/WMA
Tuning range	76~108.0MHz	520~1710KHz	---
Sensitivity	4uV(S/N=30dB)	63uV(S/N=20dB)	---
S/N ratio	50 dB	45 dB	60 dB
Stereo separation	>25 dB	---	50dB
Freq. Response	40Hz~12KHz	100Hz~2KHz	20Hz~16KHz

FOR MORE LANGUAGES, PLEASE SCAN QR CODE BELOW:

**PARA MÁS IDIOMAS, FAVOR ESCANEAR EL CÓDIGO QR
ABAJO:**

**POUR PLUS DE LANGUES, VEUILLEZ SCANNER LE CODE QR
CI-DESSOUS :**



BP Americas Corp.
Doral, Florida 33178 USA
www.bpcarusa.com

BP Americas Paraguay S.A.
Asunción, Paraguay
info@bpamericas.com