

BLAUPUNKT



DSP WITH CLASS D
AMPLIFIER **MPD 101280 AH**



Enjoy it.

Operating and Installation Instructions

CAUTIONS

This device has been manufactured according to established safety guidelines. However, dangers may still occur if the safety notes in this manual is not observed. This manual is intended to familiarize the user with the device's important functions. Read this carefully, prior to using the car radio. Keep this manual in an easily accessible location. In addition, do observe the instructions of other devices used in conjunction with this device.

Installation Safety Notes

Always observe the following safety notes:

- Device must be used in a way that compliments safety of the user when driving the vehicle. It is recommended for the user to install at an appropriate location when operating the device. While driving, user is not recommended to use applications that can be prone to distraction.
- Before installation, disconnect the negative terminal of the battery. Refer to the safety vehicle manufacturer's user manual.
- Ensure positions of the holes are nowhere near the vehicle component to avoid any damage during drilling.
- Ensure cross section of the cables is not more than 5mm if the positive and the negative cables are too long. incorrect installation may result in malfunction of the device or the car sound system.
- Select a dry and well-ventilated location to install the device.
- The device must not be installed in overly exposed location.
- The installation location must be suitable for screw holes and stable ground support

General Safety Notes:

Observe the following for protection against injuries:

- User is advised to keep the volume of the car radio to a moderate level for the protection of the ears and to increase the ability to hear any emergency warning signals (e.g. police and ambulance sirens). Do not increase the car radio volume while the car radio is muted as it is not audible. The car radio volume can be too loud when the car radio is unmuted.

Disclaimer

- Blaupunkt is not liable for any loss or damage caused or resulting from unauthorized disassembly or modification to the product.
- In no event shall Blaupunkt be liable for any direct, indirect, punitive, incidental, special consequential damages, to property or life, improper storage, whatsoever arising out of or connected with the use or misuse of our products.
- USA & CANADA: This product is not intended for sale in the United States and Canada. If purchased in the U.S. or Canada, this product is purchased on as-is basis. No warranty, whether expressed or implied is provided in the U.S. or Canada.

Voltage Supply

- +12V : Positive connection terminal for car 12V power supply.
- GND : Power supply negative connection terminal.
- Firmly and carefully connect the ground lead to a bare metal point on the vehicle chassis.
- Operation temperature : 0° - 70°C

Compatible PC OS

- PC - with or higher than Windows XP

Scope of Delivery

- Digital Signal Processor (254 x 186.3 x 46.7mm)
- 1.5m USB Type-B Cable
- Remote Controller (optional)
- 4x Parker Type Screws (M4x20mm)
- 1x 12Pin Speaker Output Cable
- 1x 16 Pin Speaker Output Cable
- 1x 20Pin High Level Input Cable

Disposal Notes



Do not dispose of your old unit in the household trash!
Use the return and collection systems available to dispose of the old device.

This manual may be updated from time to time without any notice. Visit www.blaupunkt.com for more info.

INPUT FUNCTION

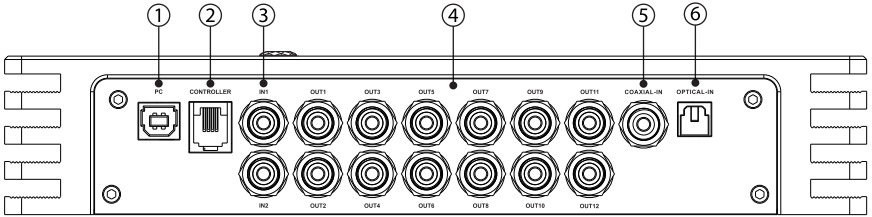

1. USB2.0 Type-B
2. Remote Control
3. Low Level RCA Input
4. Low Level RCA Output
5. Coaxial Input
6. Optical Input

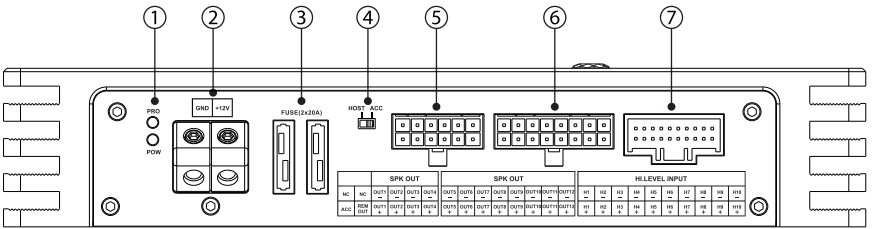

1. Power & Protection LED indicator
2. Power Input (GND & +12V)
3. Fuse (2x20A)
4. HOST/ ACC Converter
5. CH1~CH4 Speaker Output/ ACC/ Remote Out
6. CH5~CH12 Speaker Output
7. CH1~CH10 High Level Input

INSTALLATION

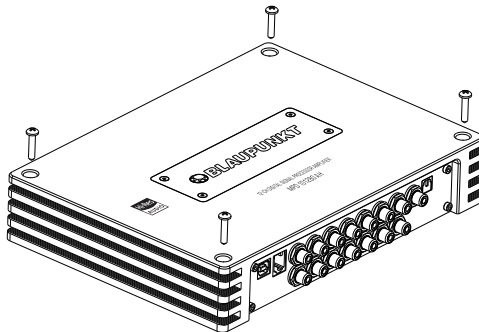

SPECIFICATION

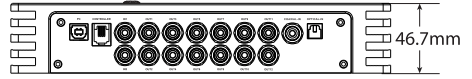
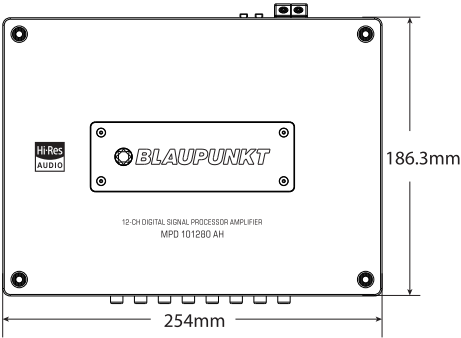

Audio

- RMS Power : 40W x 12 at 4Ω
- DSP Resolution : 32Bit
- DSP Power : 295MHz
- Max Output Power @ 4 Ohms(≤10% THD + N) : 80W x 12
- Distortion (THD) : <0.05%
- Operating Voltage : 9V-16V
- Sampling Rate : 96kHz/32Bit
- Signal Converter A/D : PCM1840
- Signal Converter D/A : PCM1681
- RCA/Cinch Input Sensitivity : 6.5V
- Max. RCA/Cinch Output : 8V

Input

- 2 x Low Level RCA Input
- 1 x Coaxial Input
- 10 x High Level Speaker Input
- 1 x Optical SPDIF Input
- 1 x USB Input (To computer)

- High Level Input Sensitivity : 34V
- Low Level Input Impedance : 10k Ohms
- High Level Input Impedance : 4.7 Ohms
- S/N Ratio Digital-in : ≥97dB
- S/N Ratio Analog-in : ≥97dB

Output

- 12 x RCA/Cinch Output
- 12 x High Level Speaker Output

Feature

- Class D Amplifier
- Max. Output Power : 960W
- Frequency Response : 20Hz-40kHz
- Max. Current Consumption : 40A
- Dimension (W x H x D) : 254 x 186.3 x 46.7mm
- Weight : 3.1kg

Accessories



1 x 20 Pin High Level
Input Cable



1 x 12 Pin Speaker
Output Cable



1 x 16 Pin Speaker
Output Cable



4 x Parker Type Screws
(M4x20mm)



1 x 1.5m USB Type-B Cable



1 x Remote Control
(Optional)

WIRING DIAGRAM

Universal Wiring Method

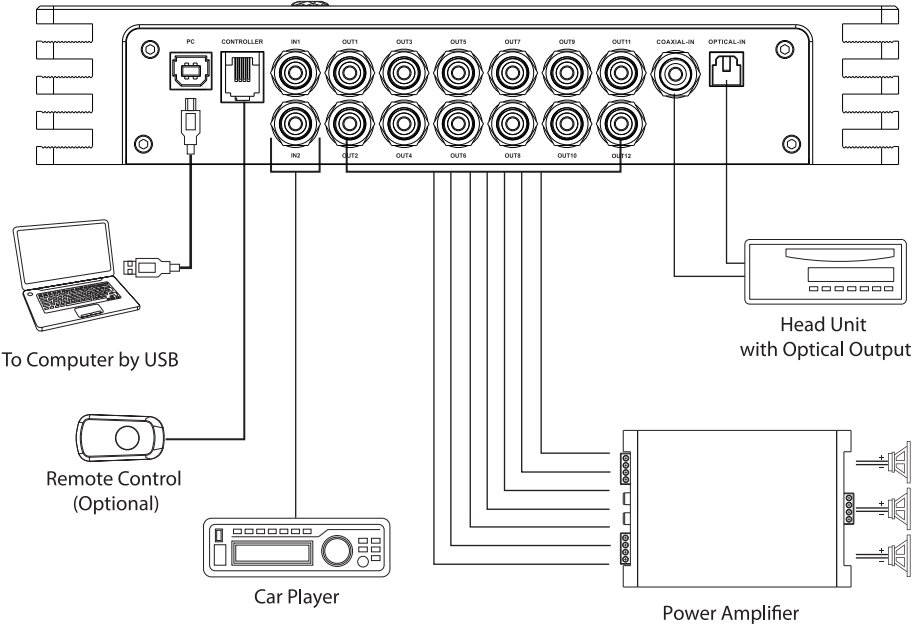
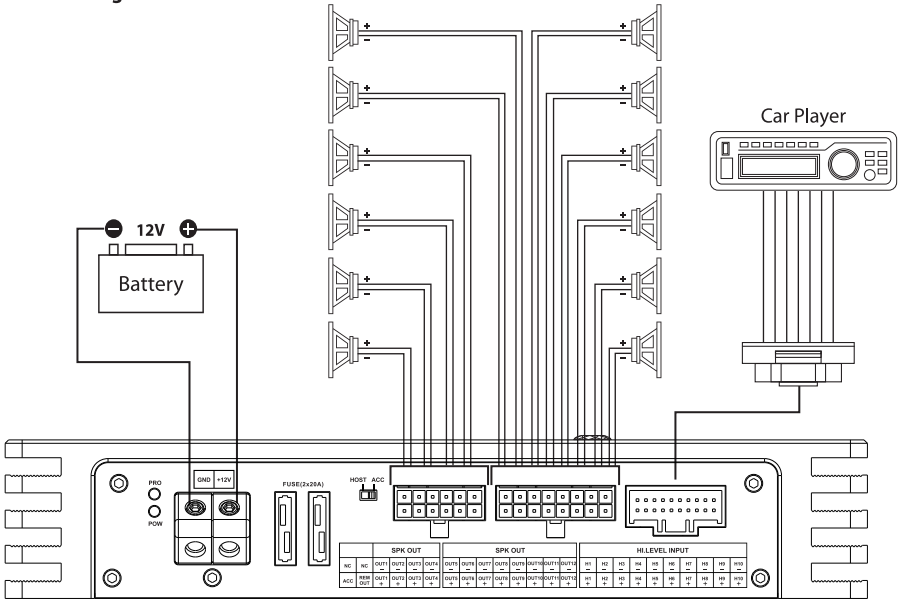

SOFTWARE OPERATION (WINDOWS)

Blaupunkt MPD 101280 AH Software

Visit www.blaupunkt.com to download the software.



MPD 101280 AH.exe

Car entertainment enthusiast / experts may now begin to tune signal details. Enhance the sound effect according to your very own preference for optimum music enjoyment with the DSP software.



Channel Panel (31-band Tuning)

1. 31-Band Tuning Waveform

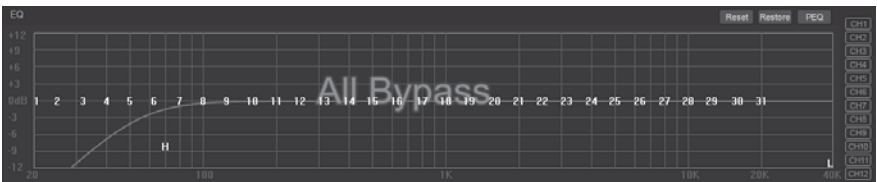

2. 31-Band Equalizer Control



SOFTWARE OPERATION (WINDOWS)

3. 12-Channel Control



4. Crossover Frequency Setting :

- 3 Types of High-pass Frequency
- 3 Types of Low-pass Frequency

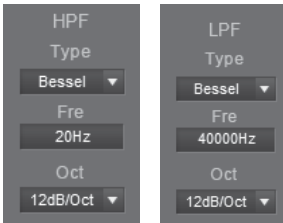

5. Main Volume Control

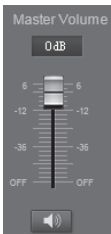

SOFTWARE OPERATION (MOBILE APPLICATION)

Mobile Application

Download "Blaupunkt MPD 101280 AH" App from Google Play (Android) or APP Store (iOS).



Blaupunkt MPD 101280 AH

Main Interface

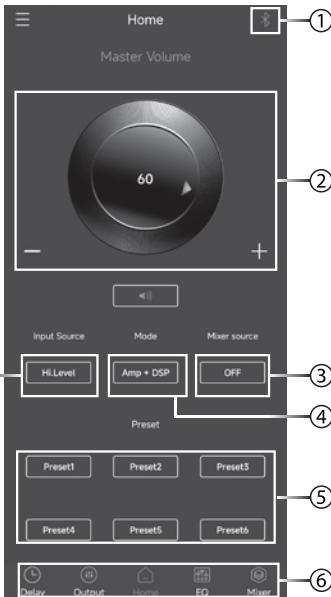

1. BT Connection

- Click on the BT icon to obtain available devices and connect to the MPD 101280 AH device corresponding to BT.

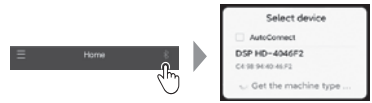

2. Adjustment of Main Volume

- Adjust the main volume by rotating the knob clockwise or counterclockwise.



3. Main Source/Mixer source

- Select the main audio source/mixer audio source in the pop-up window.

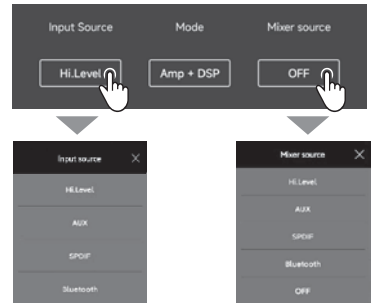

4. Power Amplifier

- Click on "Amplifier + DSP" to switch to "DSP" mode.



5. Memory

- 6 Presets



SOFTWARE OPERATION (MOBILE APPLICATION)

6. Function interface selection

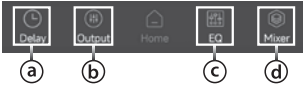

a. Delay Interface



b. Channel Interface



c. EQ Interface

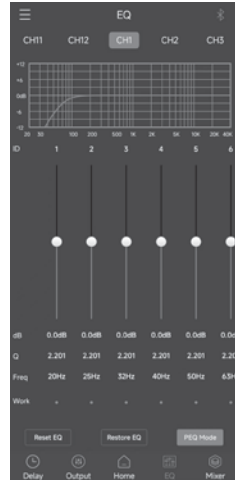

d. Mixer Interface



TROUBLESHOOTING

If any of the following problem occur, please refer to Troubleshooting for the possible solutions. Consult Blaupunkt authorized dealer if problem persist.

Problem	Solution
Amplifier power up failure	Examine if the ground connection is intact.
	Examine if remote input has at least 5V DC.
	Examine if battery power is connected correctly to the + terminal.
	Ensure supplied voltage is minimum 12V.
	Examine if fuse is broken and replace if necessary.
	Restart the device if protection LED light is on.
No sound output	Examine fuses and replace if necessary.
	Examine if ground connection is intact.
	Examine if remote input has at least 5V DC.
	Examine if RCA audio cables are connected to the right inputs.
	Examine if speaker wiring is intact.
Low sound output	Reset Level Control
	Examine the Crossover Control setting.
Buzzing noise	Observe if the device is still producing noise after turning on and off the amplifier. If yes, examine if the cables are correctly connected and if the cables and radio are in good condition.
	Repair or replace if the cables or the radio are not in good condition.
Squealing noise interference	Ensure RCA connections are properly connected.
Distorted sound output	Ensure input level of the device matches the signal level of the head unit.
	Always set the input level to the lowest.
	Examine if crossover frequency is set correctly.
	Examine if speaker wire had short-circuit.
Amplifier temperature increased	Examine if the minimum speaker impedance for the amp models is correct.
	Ensure good air ventilation around the device. Add external cooling fan if necessary.
Engine noise (static sound) interference	Usually caused by poor RCA cable quality, which release noise. Use only the best quality cables, and route them away from power cables.
Engine noise (alternator whine) interference	Examine if RCA cable are nowhere near or attached to the vehicle chassis.
	Examine if head unit is properly connected to the wires.

